

## 695 / 795 / 1095 / 1595 / Mark IV / Mark V / Mark VII / Mark X Electric Airless Sprayers

332916D

EN

*For Portable Airless Spraying of Architectural Coatings and Paints.*

*For professional use only. Not approved for use in European explosive atmosphere locations.*

3300 psi (227 bar, 22.7 MPa) Maximum Working Pressure



### Important Safety Instructions

Read all warnings and instructions in this manual and related manuals. Be familiar with the controls and the proper usage of the equipment. Save these instructions.

#### Related Manuals:



332918  
333281



309495  
308491  
311861  
311254



333028  
332922

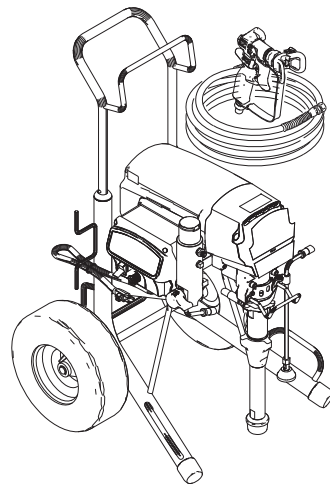

Standard Hi-Boy Series

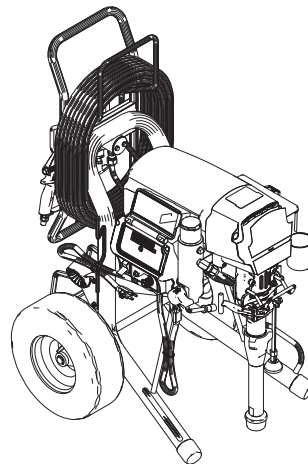

ProContractor Series

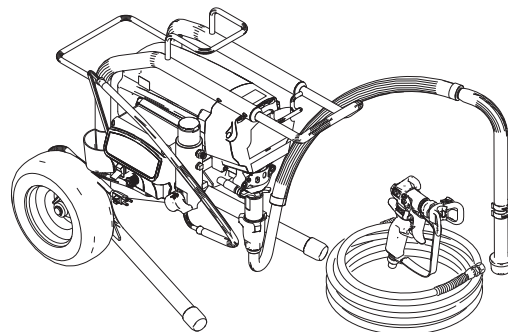

Standard Lo-Boy Series

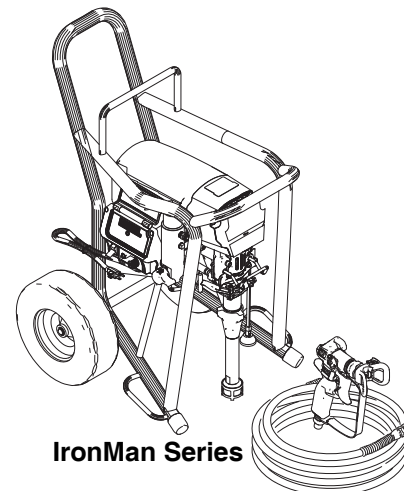

IronMan Series

ti22882a



# Table of Contents

<b>Models</b> .....	<b>3</b>	<b>Clearing Tip Clog</b> .....	<b>16</b>
UltraMax II, Ultimate Max II Models: .....	3	<b>Fast Flush</b>	
TexSpray Models: .....	4	<b>(ProContractor and IronMan models only)</b> ..	<b>17</b>
<b>Warnings</b> .....	<b>5</b>	<b>WatchDog™ Protection System</b>	
<b>Component Identification</b> .....	<b>8</b>	<b>(ProContractor and IronMan models only)</b> ..	<b>17</b>
695 / 795 / 1095 / 1595 / Mark IV / Mark V / Mark VII / Mark X		<b>ProGuard</b> .....	<b>18</b>
Standard Models: .....	8	Standard Models .....	18
695 / 795 / 1095 / 1595 Mark IV / Mark V / Mark VII / Mark X ProContractor Models: .....	9	ProContractor and IronMan Models .....	18
1095 / 1595 / Mark V IronMan Models: .....	10	<b>Hose Reel</b> .....	<b>19</b>
<b>Grounding</b> .....	<b>11</b>	(ProContractor models only) .....	19
Power Requirements .....	11	<b>Digital Tracking System</b>	
Extension Cords .....	11	<b>(ProContractor and IronMan models only)</b> ..	<b>20</b>
Pails .....	12	Operation Main Menu .....	20
<b>10/16 Amp Switch</b> .....	<b>12</b>	Change Display Units .....	20
<b>15/20 Amp Switch</b> .....	<b>12</b>	Job Gallons .....	20
<b>Pressure Relief Procedure</b> .....	<b>13</b>	Lifetime Gallons .....	20
<b>Setup</b> .....	<b>14</b>	Secondary Menu - Stored Data .....	21
<b>Startup</b> .....	<b>15</b>	<b>Cleanup</b> .....	<b>22</b>
.....	15	<b>Troubleshooting</b> .....	<b>24</b>
<b>Switch Tip Installation</b> .....	<b>16</b>	Mechanical/Fluid Flow .....	24
<b>Spray</b> .....	<b>16</b>	Electrical .....	27
		<b>Technical Data</b> .....	<b>36</b>
		<b>Graco Standard Warranty</b> .....	<b>44</b>

# Models

## UltraMax II, Ultimate Max II Models:

<b>695 UltraMax, Standard, ProContractor, IronMan Models</b>					
<b>Model</b>	<b>Voltage</b>	<b>Standard Hi-Boy</b>	<b>Standard Lo-Boy</b>	<b>ProContractor</b>	<b>IronMan</b>
16W892	120	✓			
16W893	120		✓		
16W894	120			✓	
826177	120	✓			
826178	120		✓		
826179	120			✓	
16X656	230	✓			
16X657	230	✓			
16X658	120	✓			
16X659	120	✓			
16X660	230	✓			
16X811	120		✓		
16X812	230		✓		
16Y635	230			✓	
16Y637	230			✓	
16Y638	120			✓	
16Y639	230			✓	
<b>795 UltraMax, Standard, ProContractor, IronMan Models</b>					
16W895	120	✓			
16W896	120			✓	
826180	120	✓			
826181	120			✓	
16X813	230		✓		
16X870	230	✓			
16X871	230	✓			
16X872	120	✓			
16X873	230	✓			
16Y895	230			✓	
16Y896	230			✓	
16Y897	230			✓	
16Y898	120			✓	
16Y899	120			✓	
<b>1095 UltraMax, Standard, ProContractor, IronMan Models</b>					
16W899	120	✓			
16W900	120			✓	
16W901	120				✓
826182	120	✓			
826183	120			✓	
826184	120				✓
16X874	230	✓			
16X875	230	✓			
16X881	230	✓			
16X882	120	✓			
16Y829	230			✓	
16Y830	230			✓	
16Y831	120			✓	
16Y832	230			✓	
16Y833	120			✓	
16Y869	230				✓
16Y871	230				✓

Models

1595 UltraMax, Standard, ProContractor, IronMan Models					
Model	Voltage	Standard Hi-Boy	Standard Lo-Boy	ProContractor	IronMan
16W902	120	✓			
16W903	120			✓	
16W907	120				✓
16W936	120	✓			
16W937	120			✓	
16W938	120				✓
826185	120	✓			
826186	120			✓	
826187	120				✓
826188	120	✓			
826189	120			✓	
826190	120				✓

TexSpray Models:

Mark IV / Mark V / Mark VII / Mark X Standard, ProContractor, IronMan Models												
Model Number	Model	Voltage	Standard Hi-Boy	Pro Contractor	IronMan	Flex Plus Gun	Blue Texture Gun	HD Inline Texture Gun	3/8 in. x 50ft + 1/4 in. x 3 ft whip (9.5mm x 15m + 6.4mm x 0.9m whip)	3/8 in. x 100 ft + 1/4 in. x 3 ft whip (9.5mm x 30m + 6.4mm x 0.9m whip)	1/2 in. x 50 ft + 3/8 in. x 12 ft whip (12.7mm x 15m + 9.5mm x 3.7m whip)	1/2 in. x 100 ft + 3/8 in. x 12 ft whip (12.7mm x 30m + 9.5mm x 3.7m whip)
16W897	Mark IV	120	✓			✓			✓			
16W898	Mark IV	120		✓		✓				✓		
16X953	Mark IV	230	✓			✓			✓			
16X954	Mark IV	230	✓			✓			✓			
16X956	Mark IV	230	✓			✓			✓			
16Y892	Mark IV	230		✓		✓				✓		
16Y893	Mark IV	230		✓		✓				✓		
16Y894	Mark IV	230		✓		✓				✓		
16W905	Mark V	120	✓				✓		✓			
16W906	Mark V	120		✓			✓			✓		
16W939	Mark V	120	✓				✓		✓			
16W940	Mark V	120		✓			✓			✓		
16X944	Mark V	230	✓				✓		✓			
16X947	Mark V	120			✓		✓			✓		
16X965	Mark V	230	✓				✓		✓			
16X966	Mark V	120	✓				✓		✓			
16X967	Mark V	230	✓				✓		✓			
16Y533	Mark V	120			✓		✓			✓		
16Y864	Mark V	230		✓			✓			✓		
16Y865	Mark V	230		✓			✓			✓		
16Y866	Mark V	120		✓			✓			✓		
16Y867	Mark V	230		✓			✓			✓		
16Y868	Mark V	120		✓			✓			✓		
16Y872	Mark V	230			✓		✓			✓		
16Y874	Mark V	230			✓		✓			✓		
16Y763	Mark VII	230	✓					✓			✓	
16Y919	Mark VII	230	✓					✓			✓	
16Y920	Mark VII	230		✓			✓					✓
16Y921	Mark VII	230		✓			✓					✓
16W908	Mark X	230	✓				✓				✓	
16X099	Mark X	230		✓			✓					✓
16Y534	Mark X	230	✓				✓				✓	
16Y535	Mark X	230	✓				✓				✓	
16Y536	Mark X	230	✓				✓				✓	
16Y910	Mark X	230		✓			✓					✓
16Y912	Mark X	230		✓			✓					✓
16Y913	Mark X	230		✓			✓					✓

# Warnings

The following warnings are for the setup, use, grounding, maintenance, and repair of this equipment. The exclamation point symbol alerts you to a general warning and the hazard symbols refer to procedure-specific risks. When these symbols appear in the body of this manual or on warning labels, refer back to these Warnings. Product-specific hazard symbols and warnings not covered in this section may appear throughout the body of this manual where applicable.

## ! WARNING



### GROUNDING

This product must be grounded. In the event of an electrical short circuit, grounding reduces the risk of electric shock by providing an escape wire for the electric current. This product is equipped with a cord having a grounding wire with an appropriate grounding plug. The plug must be plugged into an outlet that is properly installed and grounded in accordance with all local codes and ordinances.

- Improper installation of the grounding plug is able to result in a risk of electric shock.
- When repair or replacement of the cord or plug is required, do not connect the grounding wire to either flat blade terminal.
- The wire with insulation having an outer surface that is green with or without yellow stripes is the grounding wire.
- Check with a qualified electrician or serviceman when the grounding instructions are not completely understood, or when in doubt as to whether the product is properly grounded.
- Do not modify the plug provided; if it does not fit the outlet, have the proper outlet installed by a qualified electrician.
- This product is for use on a nominal 120V or 230V circuit and has a grounding plug similar to the plugs illustrated in the figure below.

120V US

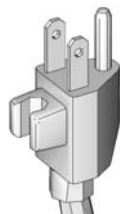

230V

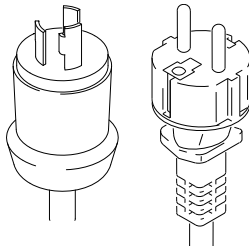

- Only connect the product to an outlet having the same configuration as the plug.
- Do not use an adapter with this product.

#### Extension Cords:

- Use only a 3-wire extension cord that has a grounding plug and a grounding receptacle that accepts the plug on the product.
- Make sure your extension cord is not damaged. If an extension cord is necessary, use 12 AWG (2.5 mm<sup>2</sup>) minimum to carry the current that the product draws.
- An undersized cord results in a drop in line voltage and loss of power and overheating.

# ! WARNING



## FIRE AND EXPLOSION HAZARD

Flammable fumes, such as solvent and paint fumes, in work area can ignite or explode. To help prevent fire and explosion:

- Do not spray flammable or combustible materials near an open flame or sources of ignition such as cigarettes, motors, and electrical equipment.
- Paint or solvent flowing through the equipment is able to result in static electricity. Static electricity creates a risk of fire or explosion in the presence of paint or solvent fumes. All parts of the spray system, including the pump, hose assembly, spray gun, and objects in and around the spray area shall be properly grounded to protect against static discharge and sparks. Use Graco conductive or grounded high-pressure airless paint sprayer hoses.
- Verify that all containers and collection systems are grounded to prevent static discharge. Do not use pail liners unless they are antistatic or conductive.
- Connect to a grounded outlet and use grounded extensions cords. Do not use a 3-to-2 adapter.
- Do not use a paint or a solvent containing halogenated hydrocarbons.
- Do not spray flammable or combustible liquids in a confined area.
- Keep spray area well-ventilated. Keep a good supply of fresh air moving through the area.
- Sprayer generates sparks. Keep pump assembly in a well ventilated area at least 20 feet (6 m) away from the spray area when spraying, flushing, cleaning or servicing. Do not spray pump assembly.
- Do not smoke in the spray area or spray where sparks or flame is present.
- Do not operate light switches, engines, or similar spark producing products in the spray area.
- Keep area clean and free of paint or solvent containers, rags, and other flammable materials.
- Know the contents of the paints and solvents being sprayed. Read all Safety Data Sheets (SDS) and container labels provided with the paints and solvents. Follow the paint and solvents manufacturer's safety instructions.
- Fire extinguisher equipment shall be present and working.



## SKIN INJECTION HAZARD

High-pressure spray is able to inject toxins into the body and cause serious bodily injury. In the event that injection occurs, **get immediate surgical treatment.**

- Do not aim the gun at, or spray any person or animal.
- Keep hands and other body parts away from the discharge. For example, do not try to stop leaks with any part of the body.
- Always use the nozzle tip guard. Do not spray without nozzle tip guard in place.
- Use Graco nozzle tips.
- Use caution when cleaning and changing nozzle tips. In the case where the nozzle tip clogs while spraying, follow the **Pressure Relief Procedure** for turning off the unit and relieving the pressure before removing the nozzle tip to clean.
- Equipment maintains pressure after power is shut off. Do not leave the equipment energized or under pressure while unattended. Follow the **Pressure Relief Procedure** when the equipment is unattended or not in use, and before servicing, cleaning, or removing parts.
- Check hoses and parts for signs of damage. Replace any damaged hoses or parts.
- This system is capable of producing 3300 psi (227 bar, 22.7 MPa). Use Graco replacement parts or accessories that are rated a minimum of 3300 psi (227 bar, 22.7 MPa).
- Always engage the trigger lock when not spraying. Verify the trigger lock is functioning properly.
- Verify that all connections are secure before operating the unit.
- Know how to stop the unit and bleed pressure quickly. Be thoroughly familiar with the controls.

# ! WARNING



## EQUIPMENT MISUSE HAZARD

Misuse can cause death or serious injury.

- Always wear appropriate gloves, eye protection, and a respirator or mask when painting.
- Do not operate or spray near children. Keep children away from equipment at all times.
- Do not overreach or stand on an unstable support. Keep effective footing and balance at all times.
- Stay alert and watch what you are doing.
- ~~Do not leave the unit energized or under pressure while unattended. When the unit is not in use, turn off the unit and follow the **Pressure Relief Procedure** for turning off the unit.~~
- Do not operate the unit when fatigued or under the influence of drugs or alcohol.
- Do not kink or over-bend the hose.
- Do not expose the hose to temperatures or to pressures in excess of those specified by Graco.
- Do not use the hose as a strength member to pull or lift the equipment.
- Do not spray with a hose shorter than 25 feet.
- Do not alter or modify equipment. Alterations or modifications may void agency approvals and create safety hazards.
- Make sure all equipment is rated and approved for the environment in which you are using it.



## ELECTRIC SHOCK HAZARD

This equipment must be grounded. Improper grounding, setup, or usage of the system can cause electric shock.

- Turn off and disconnect power cord before servicing equipment.
- Connect only to grounded electrical outlets.
- Use only 3-wire extension cords.
- Ensure ground prongs are intact on power and extension cords.
- Do not expose to rain. Store indoors.
- Wait five minutes after disconnecting power cord before servicing large capacitor units.



## PRESSURIZED ALUMINUM PARTS HAZARD

Use of fluids that are incompatible with aluminum in pressurized equipment can cause serious chemical reaction and equipment rupture. Failure to follow this warning can result in death, serious injury, or property damage.

- Do not use 1,1,1-trichloroethane, methylene chloride, other halogenated hydrocarbon solvents or fluids containing such solvents.
- Do not use chlorine bleach.
- Many other fluids may contain chemicals that can react with aluminum. Contact your material supplier for compatibility.



## MOVING PARTS HAZARD

Moving parts can pinch, cut or amputate fingers and other body parts.

- Keep clear of moving parts.
- Do not operate equipment with protective guards or covers removed.
- Pressurized equipment can start without warning. Before checking, moving, or servicing equipment, follow the **Pressure Relief Procedure** and disconnect all power sources.



## PERSONAL PROTECTIVE EQUIPMENT

Wear appropriate protective equipment when in the work area to help prevent serious injury, including eye injury, hearing loss, inhalation of toxic fumes, and burns. This protective equipment includes but is not limited to:

- Protective eyewear, and hearing protection.
- Respirators, protective clothing, and gloves as recommended by the fluid and solvent manufacturer.

## CALIFORNIA PROPOSITION 65

This product contains a chemical known to the state of California to cause cancer, birth defects or other reproductive harm. Wash hands after handling.

# Component Identification

695 / 795 / 1095 / 1595 / Mark IV / Mark V / Mark VII / Mark X  
Standard Models:

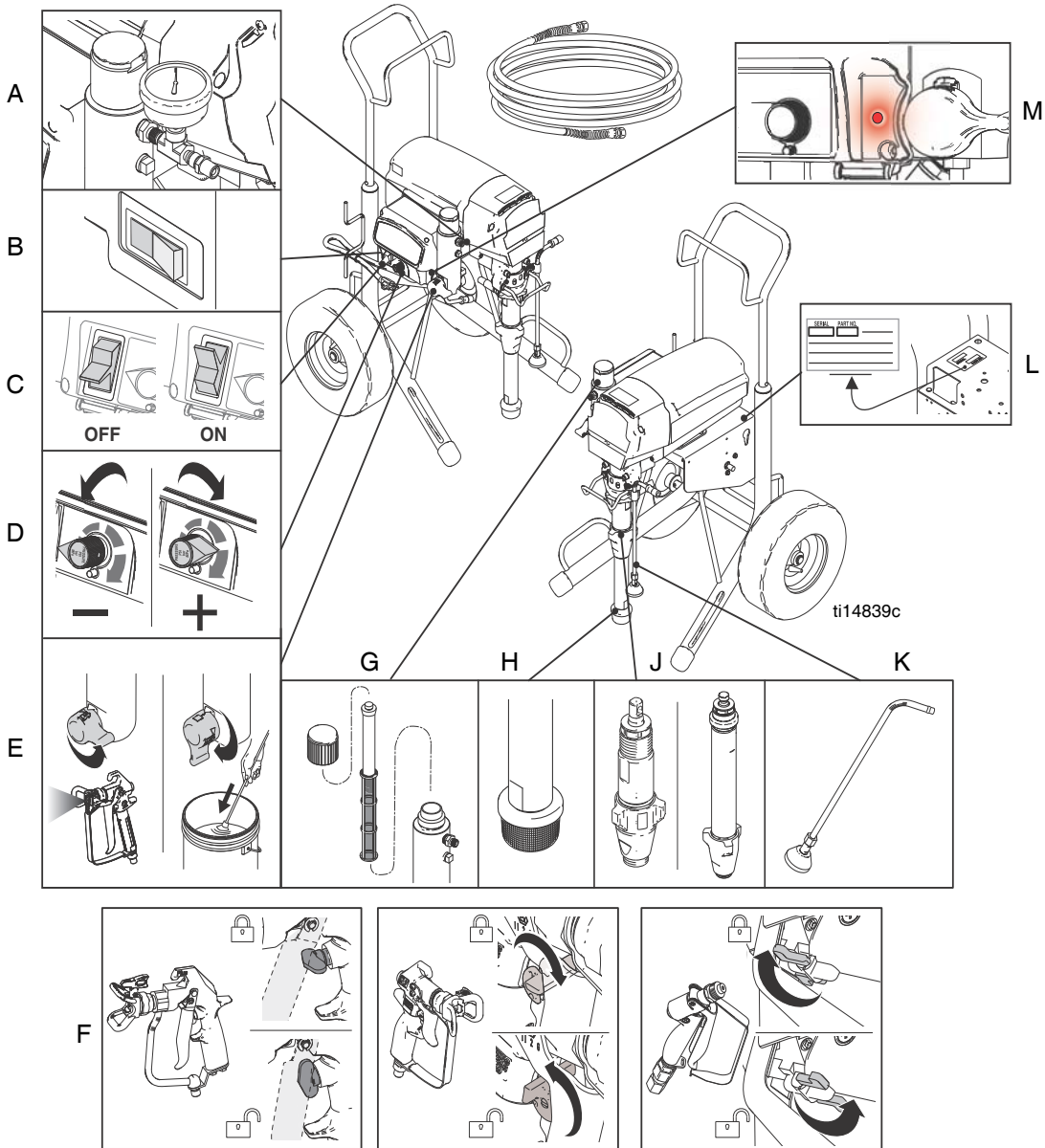

A	Pressure Gauge (not available on all units)
B	Amp Switch (not available on all units)
C	ON/OFF Switch
D	Pressure Control
E	Prime / Spray Valve
F	Trigger Lock

G	Filter
H	Strainer
J	Pump
K	Drain Tube
L	Model/Serial Tag
M	ProGuard Status Light



# 695 / 795 / 1095 / 1595 Mark IV / Mark V / Mark VII / Mark X ProContractor Models:

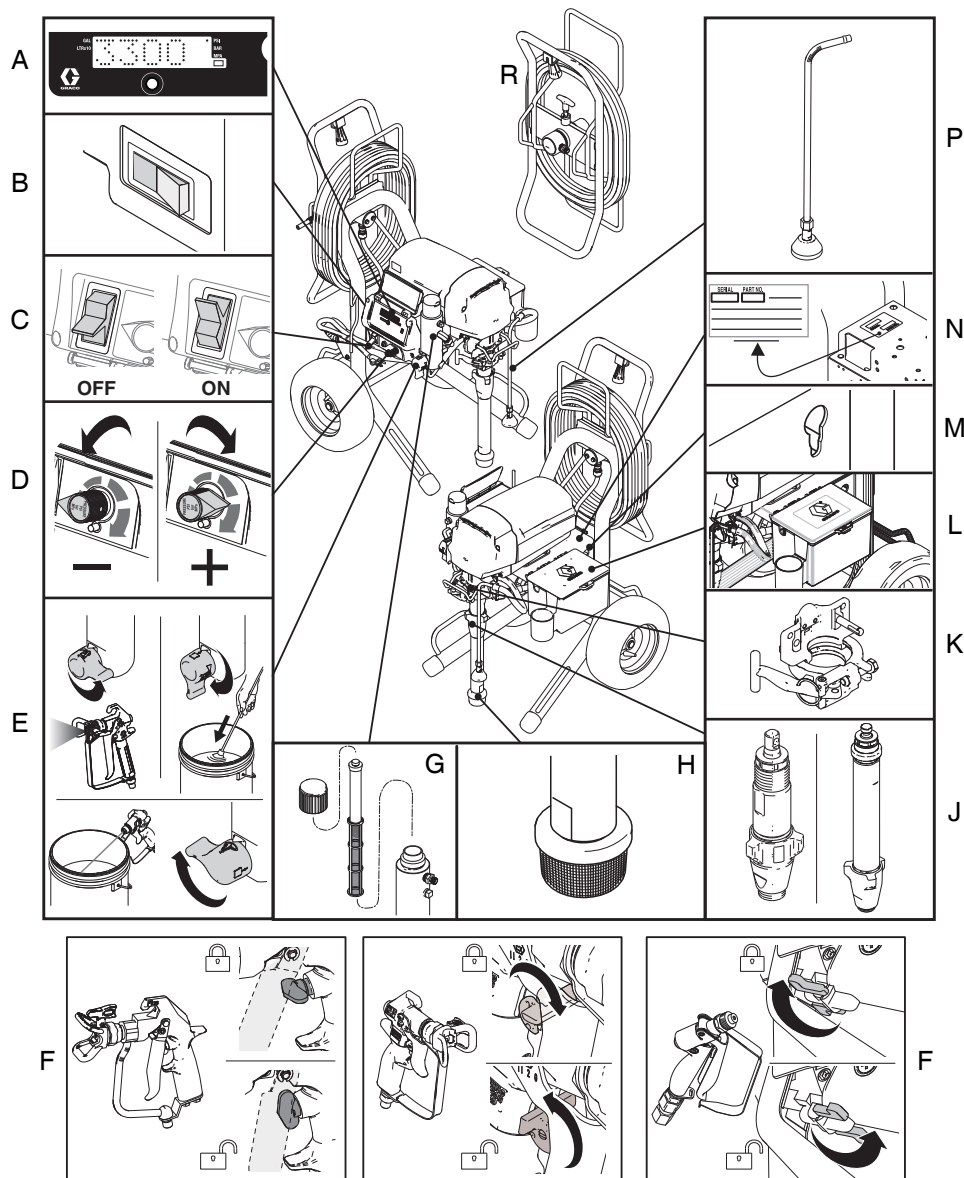

ti18239b

A	Smart Control 3.0 Display
B	Amp Switch (not available on all units)
C	ON/OFF Switch
D	Pressure Control
E	Spray / Prime / Fast Flush
F	Trigger Lock
G	Filter
H	Strainer

J	Pump
K	ProConnect™ II
L	Tool Box
M	Rod Pull Feature
N	Unit / Serial Tag
P	Drain Tube
R	QuikReel

# 1095 / 1595 / Mark V IronMan Models:

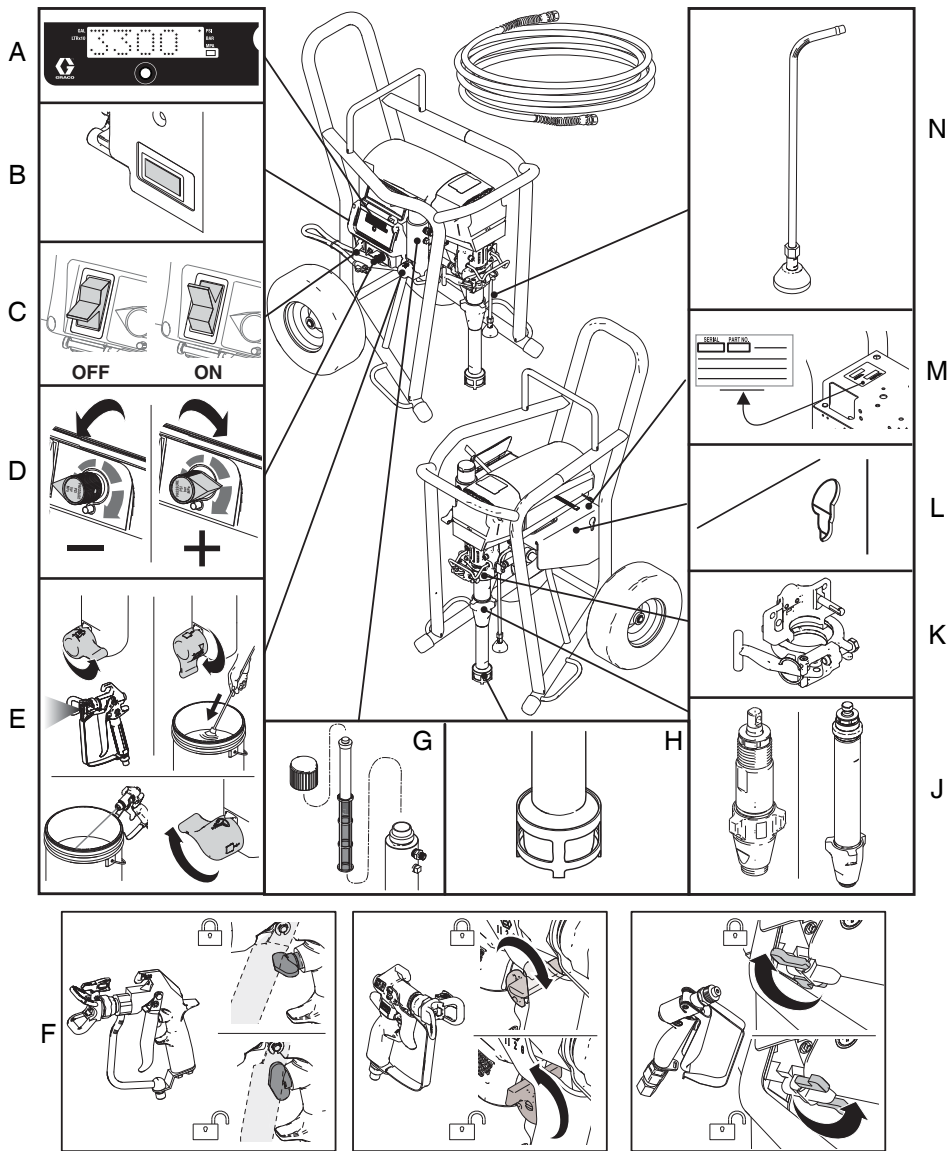





ti22935a

A	Smart Control 3.0 Display
B	Amp Switch (not available on all units)
C	ON/OFF Switch
D	Pressure Control
E	Spray / Prime / Fast Flush
F	Trigger Lock
G	Filter

H	Strainer
J	Pump
K	ProConnect™ II
L	Rod Pull Feature
M	Unit / Serial Tag
N	Drain Tube

# Grounding

						
---	---	---	---	--	--	--

The equipment must be grounded to reduce the risk of static sparking and electric shock. Electric or static sparking can cause fumes to ignite or explode. Improper grounding can cause electric shock. Grounding provides an escape wire for the electric current.

The sprayer cord includes a grounding wire with an appropriate grounding contact. Do not use the sprayer if the electrical cord has a damaged ground contact.

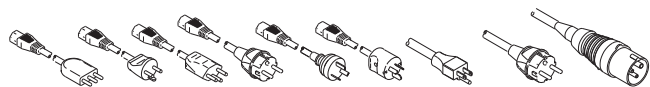

The plug must be plugged into an outlet that is properly installed and grounded in accordance with all local codes and ordinances.

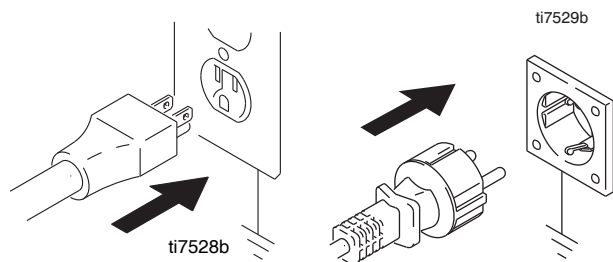

Do not modify plug! If it will not fit in outlet, have grounded outlet installed by a qualified electrician. Do not use an adapter.

## Power Requirements

- 100-120V units require 100-120 VAC, 50/60 Hz, 15A, 1 phase
- 230V units require 220-240 VAC, 50/60 Hz, 10A-16A

## Extension Cords

Use an extension cord with an undamaged ground contact.

If an extension cord is necessary, use a 3-wire, 12 AWG (2.5 mm<sup>2</sup>) minimum. Longer cords and higher gauge cords reduce sprayer performance.

## Pails



**Solvent and oil/based fluids:** follow local code. Use only conductive metal pails, placed on a grounded surface such as concrete.

Do not place pail on a nonconductive surface such as paper or cardboard which interrupts grounding continuity.



ti5850b

**Grounding a metal pail:** connect a ground wire to the pail by clamping one end to pail and other end to a true earth ground.

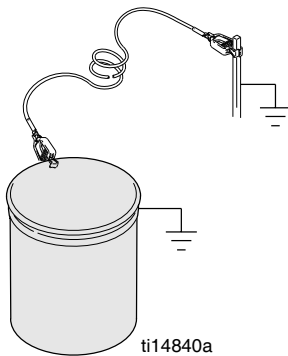

ti14840a

**To maintain grounding continuity when flushing or relieving pressure:** hold metal part of spray gun firmly to side of a grounded metal pail. Then trigger gun.

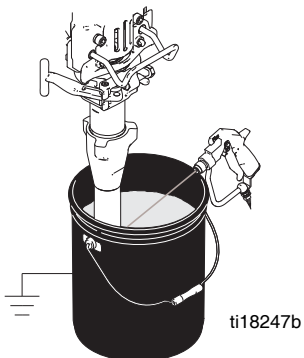

ti18247b

## 10/16 Amp Switch

(Mark VII and Mark X units)

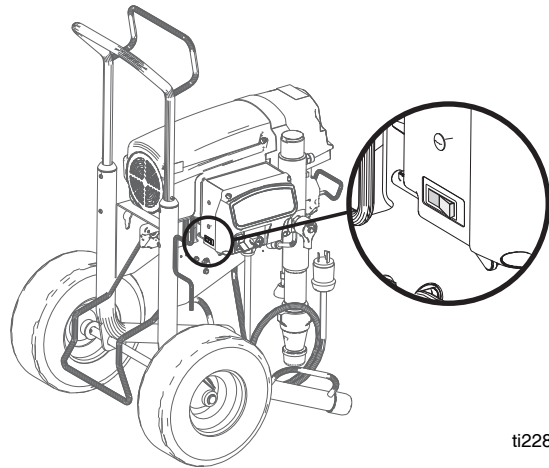

ti22874a

Select 10A or 16A setting based on your circuit rating.

## 15/20 Amp Switch

(120V 1595 and Mark V units)

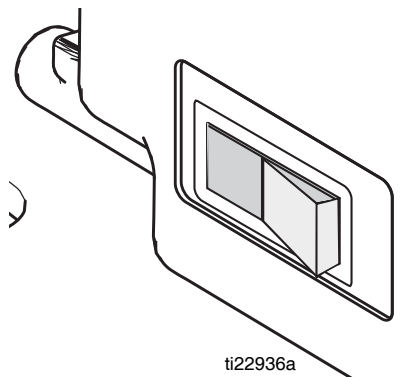

ti22936a

Select 15A or 20A setting based on your circuit rating.

# Pressure Relief Procedure



Follow the Pressure Relief Procedure whenever you see this symbol.



This equipment stays pressurized until pressure is manually relieved. To help prevent serious injury from pressurized fluid, such as skin injection, splashing fluid and moving parts, follow the Pressure Relief Procedure when you stop spraying and before cleaning, checking, or servicing the equipment.

1. Turn power **OFF**. Wait 7 seconds for power to dissipate.

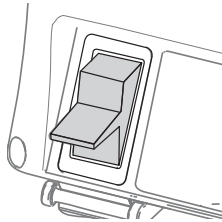

2. Engage trigger lock.

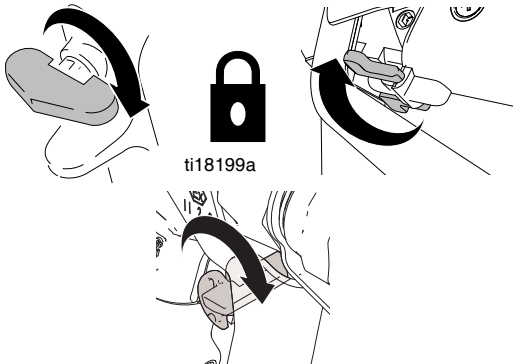

ti18199a

3. Remove guard and SwitchTip.

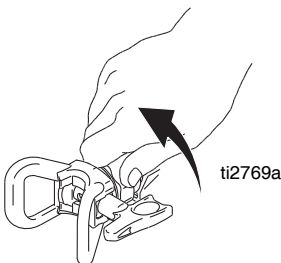

ti2769a

4. Turn pressure to lowest setting. Trigger gun to relieve pressure.

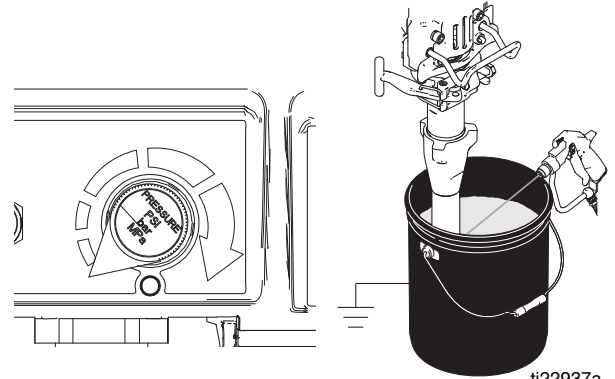

ti22937a

5. Put drain tube in pail. Turn prime valve down to DRAIN position. Leave prime valve in DRAIN position until you are ready to spray again.

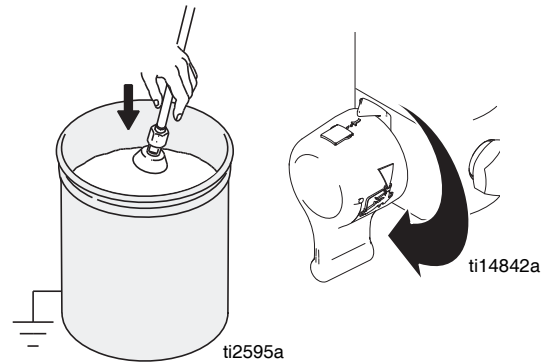

ti2595a

ti14842a

6. If you suspect the spray tip or hose is clogged or that pressure has not been fully relieved after following the steps above, **VERY SLOWLY** loosen tip guard retaining nut or hose end coupling to relieve pressure gradually, then loosen completely. Clear hose or tip obstruction.

# Setup

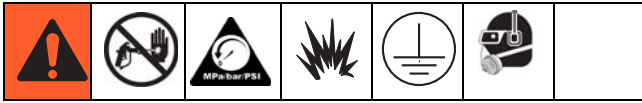

1. **All sprayers except ProContractor:** Connect Graco airless hose to sprayer. Tighten securely.

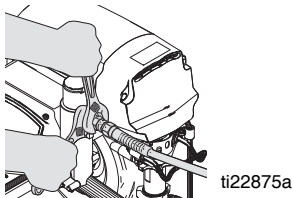

If using the optional hopper, remove the nipple fitting from the filter. Install 45° elbow (from parts box) into filter and install nipple fitting into elbow. Then connect the hose to the nipple.

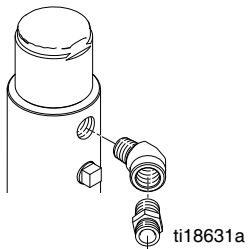

**NOTE:** Make sure nipple fitting is angled away from hopper so the hose can be easily installed.

2. Connect whip hose (if applicable) and gun to other end of hose. Tighten securely.

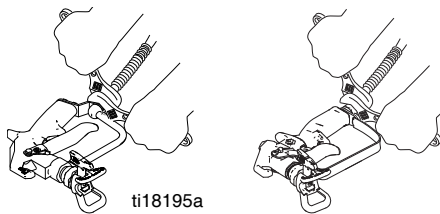

3. Engage trigger lock.

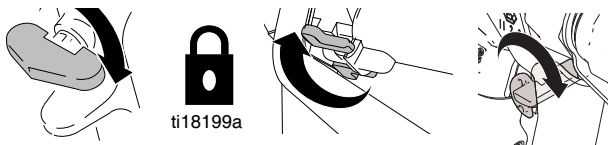

4. Remove tip guard.

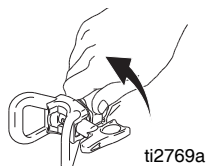

5. Check inlet strainer for clogs and debris.

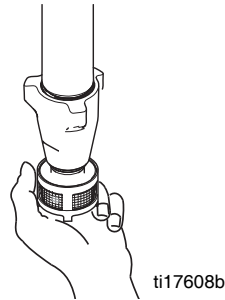

6. Fill throat packing nut with Graco TSL to prevent premature packing wear. Do this each time you spray.

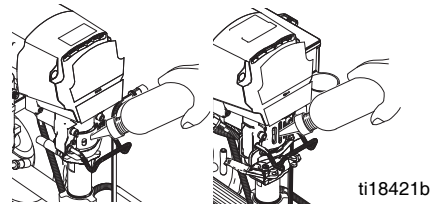

7. Turn power OFF.

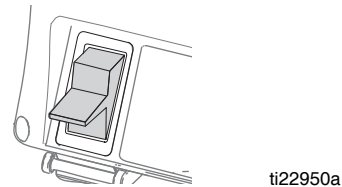

8. Plug power supply cord into a properly grounded electrical outlet.

9. Turn prime valve down to DRAIN position.

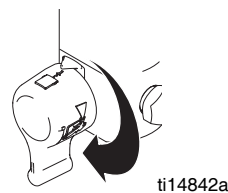

10. Place pump in grounded metal pail partially filled with flushing fluid. Attach ground wire to pail and to true earth ground. Perform steps 1 - 5 of **Startup** to flush out storage oil shipped in sprayer. Use water to flush water-base paint and mineral spirits to flush oil-base paint and storage oil.

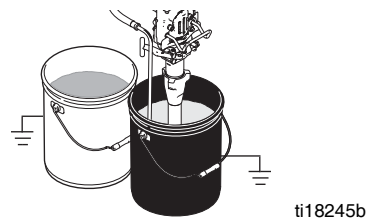

# Startup



1. Perform **Pressure Relief Procedure**, page 13.
2. Turn pressure control to lowest pressure.

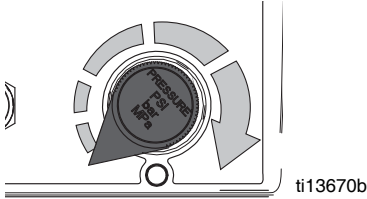

3. Turn power **ON**.

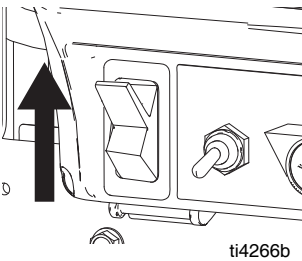

4. Increase pressure 1/2 turn to start motor and allow fluid to circulate through drain tube for 15 seconds; turn pressure down.



15sec.

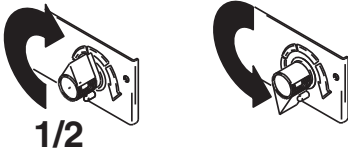

5. Turn prime valve forward to **SPRAY** position. Disengage trigger lock.

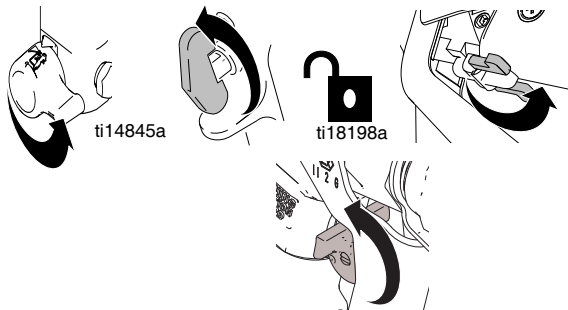

6. Hold gun against grounded metal flushing pail. Trigger gun and increase fluid pressure 1/2 turn. Flush 1 minute.

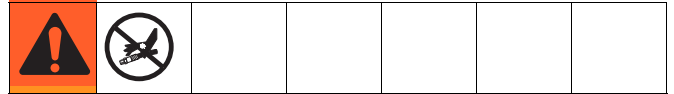
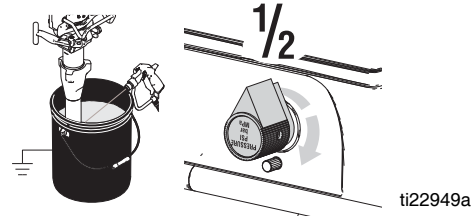

High-pressure spray is able to inject toxins into the body and cause serious bodily injury. Do not stop leaks with hand or rag.

7. Inspect for leaks. If leaks occur, perform **Pressure Relief Procedure**, page 13. Tighten fittings. Perform **Startup**, steps 1 - 5. If no leaks, proceed to step 7.

8. Place pump in paint pail.

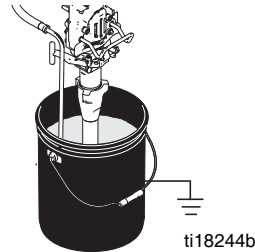

9. Trigger gun again into flushing pail until paint appears. Move gun to paint pail and trigger for 20 seconds.

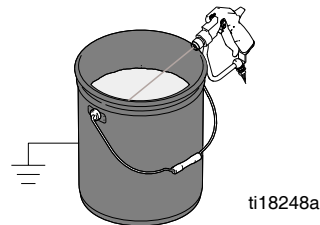

10. Engage trigger lock. Assemble tip and guard, see instructions on next page.

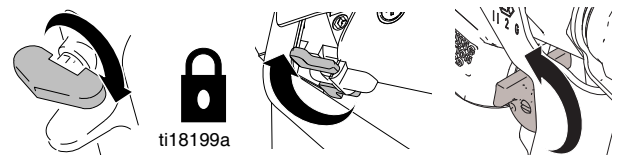



## Switch Tip Installation



1. Perform **Pressure Relief Procedure**, page 13.
2. Use spray tip (A) to insert OneSeal™ (B) into guard (C).

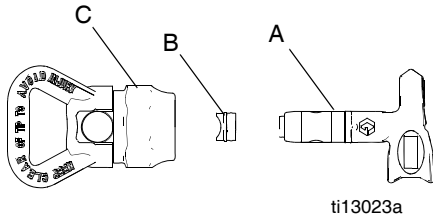

3. Insert Switch Tip.

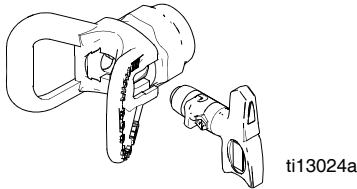

4. Screw assembly onto gun. Tighten.

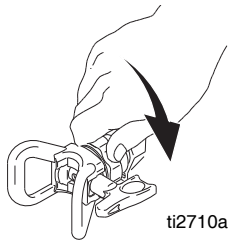

## Spray

1. Spray test pattern. Increase pressure to eliminate heavy edges. Use smaller tip size if pressure adjustment can not eliminate heavy edges.

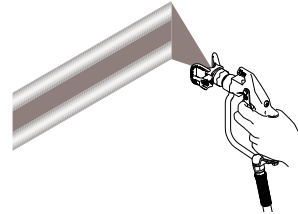

2. Hold gun perpendicular, 10-12 in. (25-30 cm) from surface. Spray back and forth. Overlap by 50%. Trigger gun after moving and release before stopping.

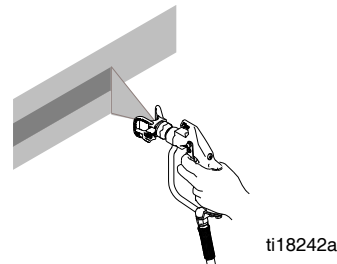

## Clearing Tip Clog



1. Release trigger, engage trigger lock. Rotate SwitchTip. Disengage trigger lock. Trigger gun to clear clog.

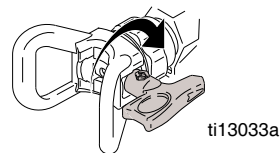

2. Engage trigger lock. Return SwitchTip to original position. Disengage trigger lock and continue spraying.

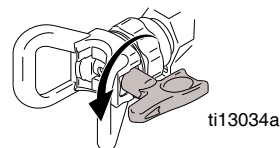



## Fast Flush (ProContractor and IronMan models only)

To flush the hose and gun at an accelerated speed, perform the following steps:

1. Perform steps 1 - 3 of **Cleanup**, page 22.
2. Squeeze gun trigger and turn prime valve down to DRAIN position and then over to FAST FLUSH.

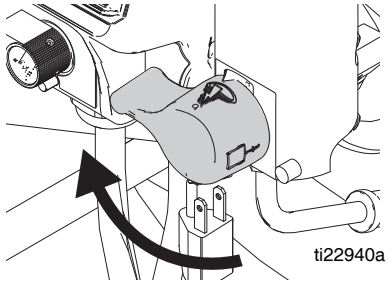

3. Continue flushing system until fluid appears clear.

## WatchDog™ Protection System (ProContractor and IronMan models only)

Pump stops automatically when material pail is empty.

### To Activate:

1. Perform **Startup**.

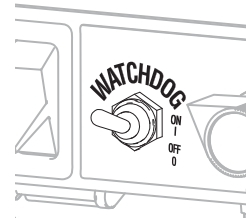

2. Turn WatchDog switch ON and **WD ON** displays. **EMPTY** displays/ flashes and pump stops when Watchdog protection system detects an empty material pail.



3. Turn WatchDog switch OFF. Add material or re-prime sprayer. Turn pump switch OFF and ON to reset WatchDog protection system. Turn WatchDog switch back ON to continue to monitor material level.

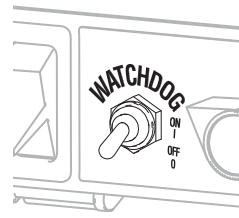



# ProGuard

This sprayer protects itself against high and low voltage. If the sprayer is plugged into a power source that is too low or too high the sprayer will stop operating.

## Standard Models

Standard models come equipped with a ProGuard status indicator light. This light has three different states of operation: ON, blink, and OFF.

Error Code	Definition
	<b>Light is ON</b> Unit is powered and operating normally.
	<b>Light is Blinking</b> Voltage supply is too low or too high for sprayer and will not run until it is plugged into a good power supply.
	<b>Light is OFF</b> No power to sprayer, or there is another error other than the voltage supply.

See **Troubleshooting** (page 24) to determine the cause of any errors.

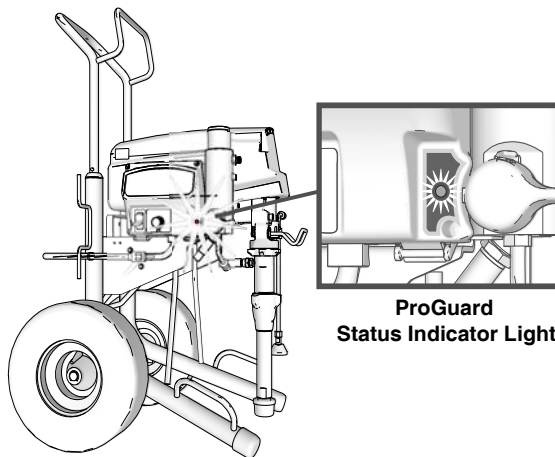

**ProGuard  
Status Indicator Light**

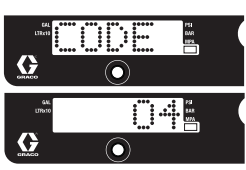
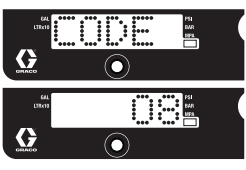
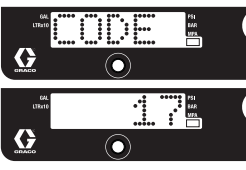

## ProContractor and IronMan Models

One of three error codes will be displayed:

Error Code	Definition
	<b>Multiple incoming voltage surges detected - unplug sprayer and locate good voltage supply to prevent damage to electronics.</b> Typical cause of this error is plugging into a circuit that is higher than the rated voltage of the sprayer. Find a circuit that supplies the correct voltage.
	<b>Incoming voltage too low for sprayer operation - unplug sprayer and locate good voltage supply to prevent damage to electronics.</b> Typical cause of this error is other equipment on the same circuit or generator frequently turning on/off under load. Find a circuit that is dedicated to the sprayer.
	<b>Sprayer plugged into wrong voltage - unplug sprayer and locate correct voltage supply.</b> Typical cause of this error is a GFCI box that is wired for the wrong voltage (240V vs. 120V). No damage has occurred to the sprayer. Find a circuit with the correct voltage and the sprayer will run correctly.

# Hose Reel

(ProContractor models only)

		
<p>Moving parts can pinch, cut or amputate fingers and other body parts. To avoid injury from moving parts, be sure to keep your head clear of hose reel while winding up hose.</p>		

1. Make sure hose is routed through hose guide.

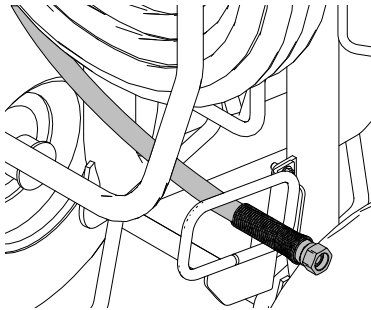

ti18241a

2. Lift and turn pivot lock 90° to unlock hose reel. Pull on hose to remove it from hose reel.

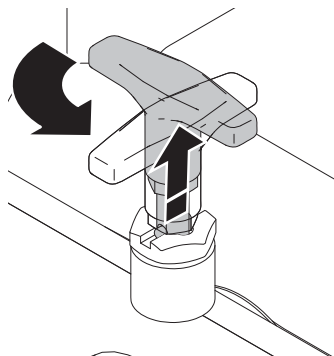

ti13501c

3. Pull reel handle up and turn clockwise to reel in hose.

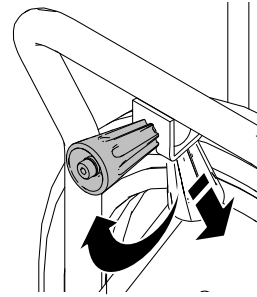

ti13503b

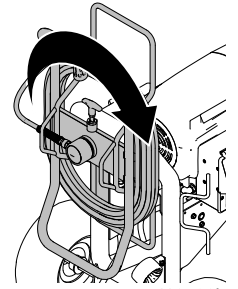

ti13502b

**NOTE:** The hose reel can be locked into two positions: Usage (A) and Storage (B).

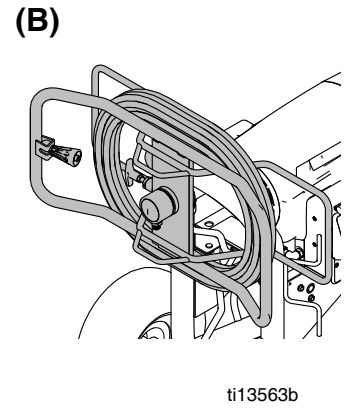
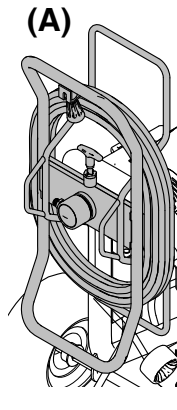

ti13563b

# Digital Tracking System

(ProContractor and IronMan models only)

## Operation Main Menu

Short press to move to next display. Press and hold (5 seconds) to change units or reset data.

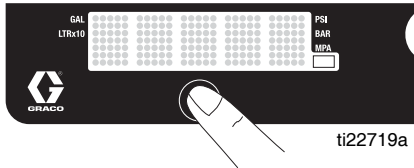

1. Turn pressure to lowest setting. Trigger gun to relieve pressure. Turn prime valve down to DRAIN position.

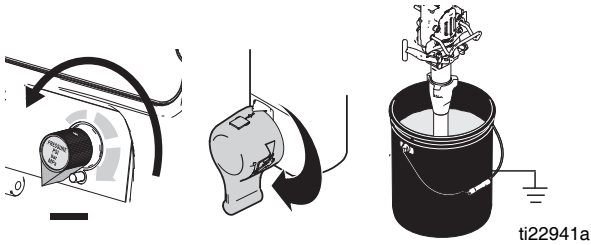

2. Turn power ON. Pressure display appears. Dashes will not appear unless pressure is less than 200 psi (14 bar, 1,4 MPa).



## Change Display Units

Press and hold DTS button for 5 seconds to change pressure units (**psi**, **bar**, **MPa**) to desired units. Selection of bar or MPa changes **gallons** to **liters x 10**. To change display units DTS must be in pressure display mode and pressure must be at zero.

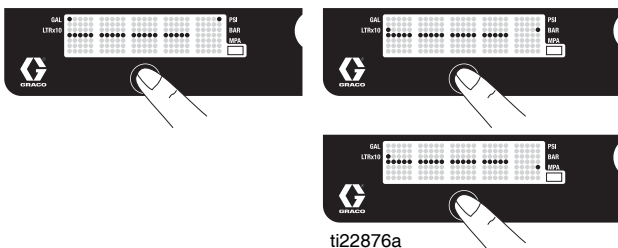

## Job Gallons

1. Short press DTS button to move to Job Gallons (or liters x 10).

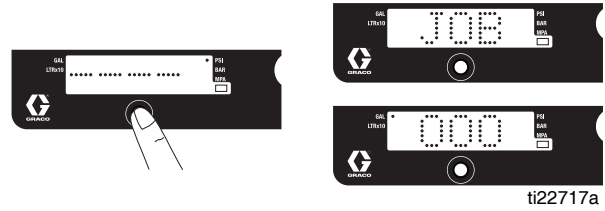

**NOTE: JOB** scrolls past, then the number of gallons sprayed above 400 psi (28 bar, 2.8 MPa) for Mark VII and Mark X displays; 1000 psi (70 bar, 7 MPa) for all other models.

2. Press and hold to reset to zero.

## Lifetime Gallons

1. Short press DTS button to move to Lifetime Gallons (or liters x 10).

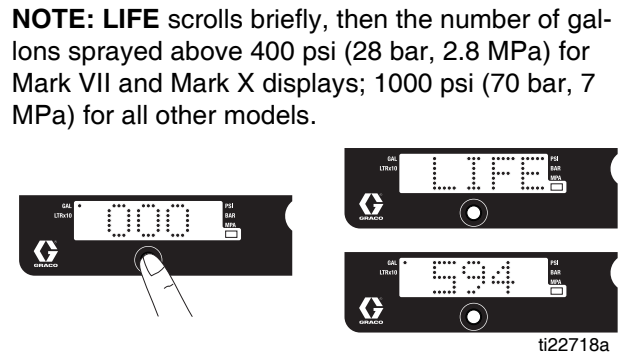

**NOTE: LIFE** scrolls briefly, then the number of gallons sprayed above 400 psi (28 bar, 2.8 MPa) for Mark VII and Mark X displays; 1000 psi (70 bar, 7 MPa) for all other models.

## Secondary Menu - Stored Data

1. Perform **Pressure Relief**, steps 1 - 4 if they have not already been done.
2. Turn power switch on while holding DTS button down.

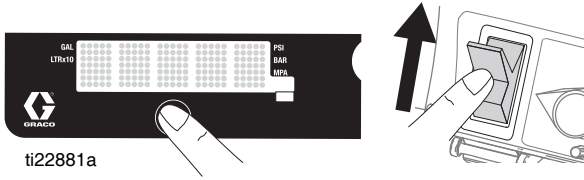

3. **SERIAL NUMBER** scrolls past and then serial number (e.g. 00001) displays.



4. Short press DTS button and **MOTOR HOURS** scrolls past and then total motor run hours are displayed.



5. Short press DTS button. **LAST CODE** scrolls by and last code is displayed; e.g. **E=07** (see Repair manual).

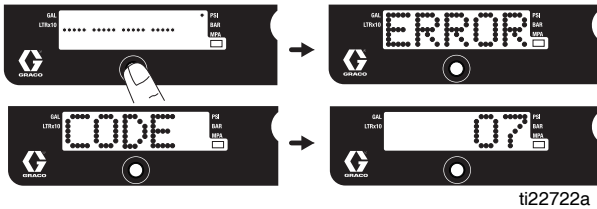

6. Press and hold DTS button to clear code to zero.



7. Short press DTS button. **W-DOG** scrolls past then **OFF** displays if watchdog switch is OFF. **ON** displays if Watchdog switch is ON.

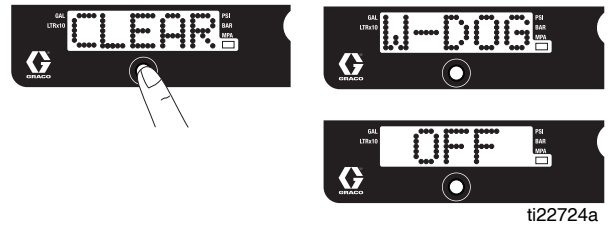

8. Press and hold (8 seconds) DTS button to move to WatchDog Trigger % menu. Continue to hold DTS button and Watchdog can be set to trigger at 30, 40, 50, or 60% of current sprayer pressure setting. Release DTS button when desired % is displayed. Default is 50%.

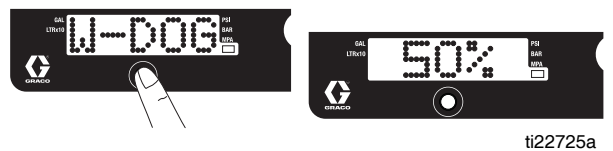

9. Short press to move to **SOFTWARE REV.**

10. Short press DTS button. **MOTOR ID RESISTOR** scrolls by and model code number (see below).

Motor ID Number	Models
0	695
2	795 / Mark IV
4	1095 / 230V Mark V
6	1595 / 120V Mark V / MARK VII
10	Mark X

# Cleanup

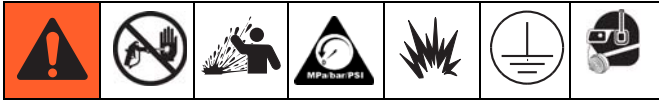

1. Perform **Pressure Relief Procedure** (page 13), steps 1 - 4. Remove tip guard from gun.

**NOTE:** Use water for water-base material, mineral spirits for oil-base material, or other solvents recommended by manufacturer.

2. Turn power **ON**. Turn prime valve forward to **SPRAY** position.

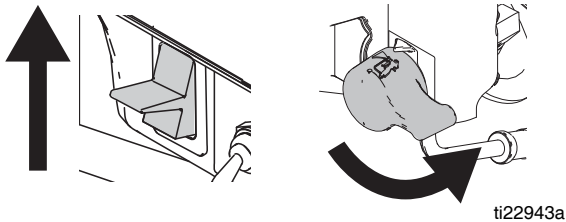

3. Increase pressure to 1/2. Hold gun against pail. Disengage trigger lock. Trigger gun until flushing fluid appears.

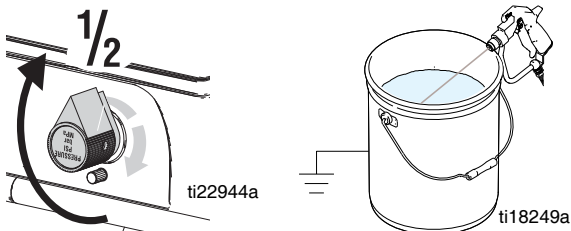

4. Move gun to waste pail, hold gun against pail, trigger gun to thoroughly flush system. Release trigger and engage trigger lock.

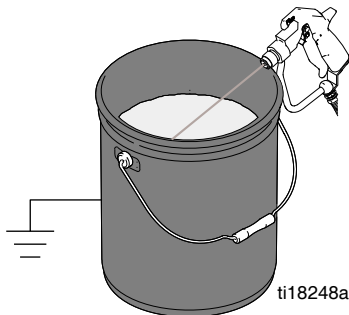

5. Turn prime valve down to **DRAIN** position and allow flushing fluid to circulate until flushing fluid appears clear.

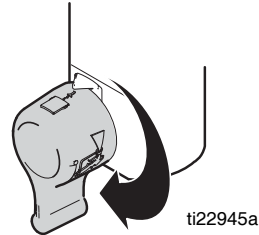

6. Turn prime valve forward to **SPRAY** position. Trigger gun into flushing pail to purge fluid from hose.

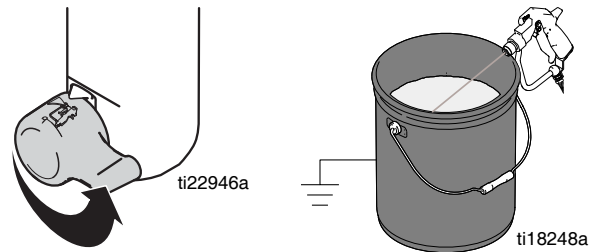

7. Raise pump above flushing fluid and run sprayer for 15 to 30 seconds to drain fluid. Turn power **OFF**.

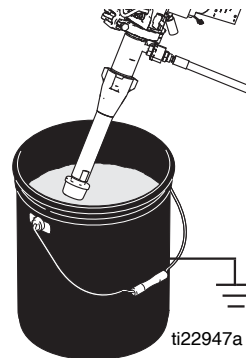

8. Turn prime valve down **DRAIN** position. Unplug sprayer.

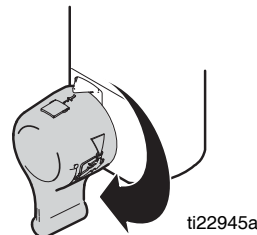

9. Remove filters from gun and sprayer, if installed. Clean and inspect. Install filters.

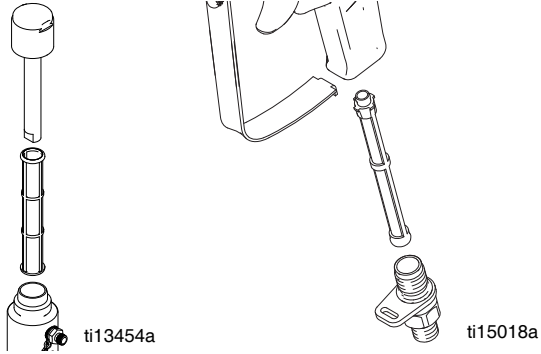

10. If flushing with water, flush again with mineral spirits, or Pump Armor, to leave a protective coating to prevent freezing or corrosion.

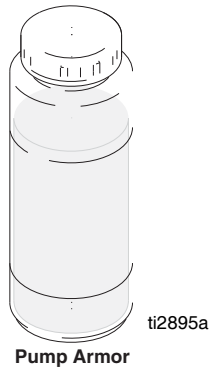

11. Wipe sprayer, hose and gun with a rag soaked in water or mineral spirits.



# Troubleshooting

## Mechanical/Fluid Flow



Perform **Pressure Relief Procedure**; page 13.

TYPE OF PROBLEM	WHAT TO CHECK If check is OK, go to next check	WHAT TO DO When check is not OK, refer to this column
<p><b>For units with display:</b> CODE XX is displayed.</p> <p><b>For units with no display:</b> ProGuard status light is blinking or the light is off and there is power to the sprayer.</p>	<p>Fault condition exists</p>	<p>Determine fault correction from table, page 27.</p>
<p>Pump output is low</p>	<p>Spray tip worn</p>	<p>Follow <b>Pressure Relief Procedure</b> on page 13, then replace tip. See your separate gun or tip manual.</p>
	<p>Spray tip clogged</p>	<p>Relieve pressure. Check and clean spray tip.</p>
	<p>Paint supply</p>	<p>Refill and reprime pump.</p>
	<p>Intake strainer clogged</p>	<p>Remove and clean, then reinstall</p>
	<p>Intake valve ball and piston ball are not seating properly</p>	<p>Remove intake valve and clean. Check balls and seats for nicks; replace if necessary; see pump manual. Strain paint before using to remove particles that could clog pump.</p>
	<p>Fluid filter, tip filter, or tip is clogged or dirty.</p>	<p>Clean filter; see operation manual.</p>
	<p>Prime valve leaking</p>	<p>Relieve pressure. Repair prime valve.</p>
	<p>Verify pump does not continue to stroke when gun trigger is released. (Prime valve not leaking.)</p>	<p>Service pump; see pump manual.</p>
<p>Leaking around throat packing nut which may indicate worn or damaged packings.</p>	<p>Replace packings; see pump manual. Also check piston valve seat for hardened paint or nicks and replace if necessary. Tighten packing nut/wet-cup.</p>	



<b>TYPE OF PROBLEM</b>	<b>WHAT TO CHECK</b> If check is OK, go to next check	<b>WHAT TO DO</b> When check is not OK, refer to this column
Pump output is low	Pump rod damage	Repair pump. See pump manual.
	Low stall pressure	Turn pressure knob fully clockwise. Make sure pressure control knob is properly installed to allow full clockwise position. If problem persists, replace pressure transducer.
	Piston packings are worn or damaged	Replace packings; see pump manual.
	O-ring in pump is worn or damaged	Replace o-ring; see pump manual.
	Intake valve ball is packed with material	Clean intake valve; see pump manual.
	Pressure setting is too low	Increase pressure; see pump manual.
	Large pressure drop in hose with heavy materials	Use larger diameter hose and/or reduce overall length of hose.
	Check to see if Amp switch (10/16 or 15/20) is on low setting. Make sure circuit is able to provide high setting.	Switch to 16A or 20A setting. Change to circuit that provides 16A or 20A. Change to less loaded circuit.
Motor runs but pump does not stroke	Displacement pump pin damaged or missing; see pump manual.	Replace pump pin if missing. Be sure retainer spring is fully in groove all around connecting rod; see pump manual.
	Connecting rod assembly damaged; see pump manual.	Replace connecting rod assembly; see pump manual.
	Gears or drive housing damaged.	Inspect drive housing assembly and gears for damage and replace if necessary; see pump manual.
Excessive paint leakage into throat packing nut	Throat packing nut is loose	Remove throat packing nut spacer. Tighten throat packing nut just enough to stop leakage.
	Throat packings are worn or damaged	Replace packings; see pump manual.
	Displacement rod is worn or damaged	Replace rod; see pump manual.
Fluid is spitting from gun	Air in pump or hose	Check and tighten all fluid connections. Cycle pump as slowly as possible during priming.
	Tip is partially clogged	Clear tip; see Operation manual.
	Fluid supply is low or empty	Refill fluid supply. Prime pump; see pump manual. Check fluid supply often to prevent running pump dry.

<b>TYPE OF PROBLEM</b>	<b>WHAT TO CHECK</b> If check is OK, go to next check	<b>WHAT TO DO</b> When check is not OK, refer to this column
Pump is difficult to prime	Air in pump or hose	Check and tighten all fluid connections. Cycle pump as slowly as possible during priming.
	Intake valve is leaking	Clean intake valve. Be sure ball seat is not nicked or worn and that ball seats well. Reassemble valve.
	Pump packings are worn	Replace pump packings; see pump manual.
	Paint is too thick	Thin the paint according to supplier recommendations.
No display, sprayer operates	Display is damaged or has bad connection	Check connections. Replace display.

# Electrical

Symptom: Sprayer does not run, stops running, or will not shut off.

Perform **Pressure Relief Procedure**; page 13.



1. Plug sprayer into correct voltage, grounded outlet.
2. Set power switch OFF for 30 seconds and then ON again (this ensures sprayer is in normal run mode).
3. Turn pressure control knob clockwise 1/2 turn.
4. View digital display.



Keep clear of electrical and moving parts during troubleshooting procedures. To avoid electrical shock hazards when covers are removed for troubleshooting, wait 5 minutes after unplugging power cord for stored electricity to dissipate.

### ProGuard Status Light

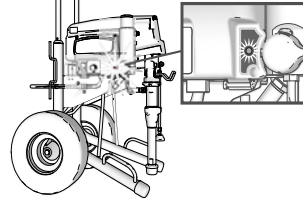

### Control Board Status Light

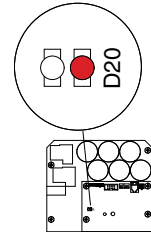

For units without a display, see **ProGuard** (page 18). If there is a voltage supply issue (CODE 04, 08, or 17), the ProGuard status light will blink continuously when the ON/OFF switch is ON. To determine which code (or any other code besides voltage supply) refer to the control board status light. Turn the ON/OFF switch OFF, remove the control cover then turn power back ON. Observe the status light. Blinking LED total count equals the error code (for example: two blinks equals CODE 02).

TYPE OF PROBLEM	WHAT TO CHECK	HOW TO CHECK
Sprayer does not run at all	See flow chart, page 33.	
Display is blank		
ProGuard status light and control board status light never light		
Sprayer does not run at all	Check transducer or transducer connections	<ol style="list-style-type: none"> <li>1. Make sure there is no pressure in the system (see <b>Pressure Relief Procedure</b>, page 13). Check fluid path for clogs, such as clogged filter.</li> <li>2. Use airless paint spray hose with no metal braid 1/4 in. x 50 ft minimum. Smaller hose or metal braid hose may result in high-pressure spikes.</li> <li>3. Set sprayer to OFF and disconnect power to sprayer.</li> <li>4. Check transducer and connections to control board.</li> <li>5. Disconnect transducer from control board socket. Check that transducer and control board contacts are clean and secure.</li> <li>6. Reconnect transducer to control board socket. Connect power, set sprayer ON and control knob 1/2 turn clockwise. If sprayer does not run properly, set sprayer to OFF and go to next step.</li> <li>7. Install new transducer. Connect power, set sprayer ON and control knob 1/2 turn clockwise. Replace control board if sprayer does not run properly.</li> </ol>
Display shows CODE 02		
Control board status light blinks 2 times repeatedly		

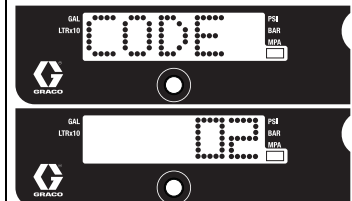

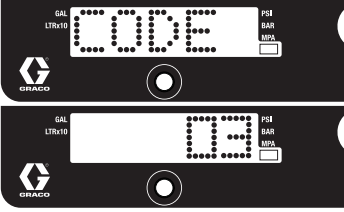
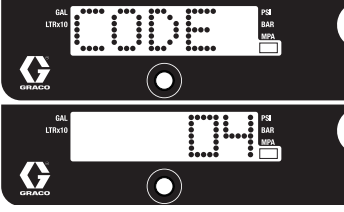
TYPE OF PROBLEM	WHAT TO CHECK	HOW TO CHECK
<p>Sprayer does not run at all</p> <p>Display shows CODE 03</p>  <p>Control board status light blinks 3 times repeatedly</p>	<p>Check transducer or transducer connections (control board is not detecting a pressure signal).</p>	<ol style="list-style-type: none"> <li>1. Set sprayer to OFF and disconnect power to sprayer.</li> <li>2. Check transducer and connections to control board.</li> <li>3. Disconnect transducer from control board socket. Check to see if transducer and control board contacts are clean and secure.</li> <li>4. Reconnect transducer to control board socket. Connect power, set sprayer ON and control knob to 1/2 turn clockwise. If sprayer does not run, set sprayer to OFF and go to next step.</li> <li>5. Connect a confirmed working transducer to control board socket.</li> <li>6. Set sprayer ON and control knob to 1/2 turn clockwise. If sprayer runs, install new transducer. Replace control board if sprayer does not run.</li> <li>7. Check transducer resistance with ohmmeter (less than 9k ohm between red and black wires and 3-6k ohm between green and yellow wires).</li> </ol>
<p>Sprayer does not run at all</p> <p>Display shows CODE 4</p>  <p>Control board status light blinks four times repeatedly</p>	<p>Check voltage supply to the sprayer (control board is detecting a multiple voltage surges).</p>	<ol style="list-style-type: none"> <li>1. Set sprayer to OFF and disconnect power to sprayer.</li> <li>2. Locate a good voltage supply to prevent damage to electronics.</li> </ol>

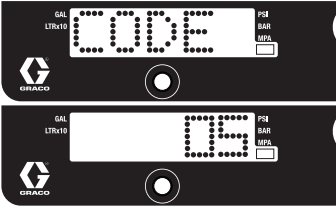
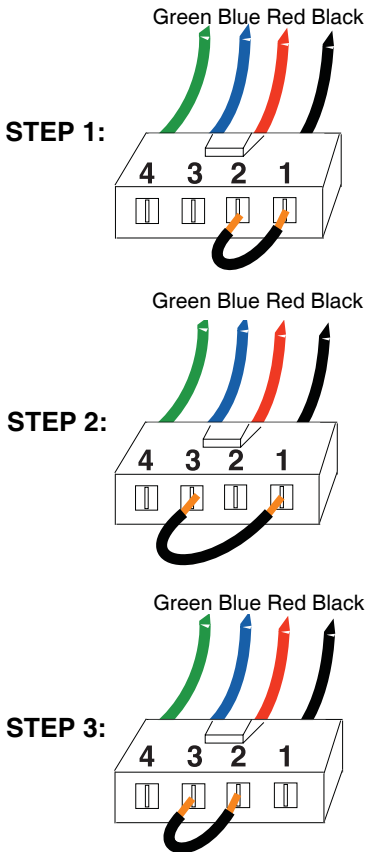
TYPE OF PROBLEM	WHAT TO CHECK	HOW TO CHECK
<p>Sprayer does not run at all</p> <p>Display shows CODE 05</p>  <p>Control board status light blinks 5 times repeatedly</p>	<p>Control is commanding motor to run but motor shaft does not rotate. Possibly locked rotor condition, an open connection exists between motor and control, there is a problem with motor or control board, or motor amp draw is excessive.</p>	<ol style="list-style-type: none"> <li>Remove pump and try to run sprayer. If motor runs, check for locked or frozen pump or drive train. If sprayer does not run, continue to step 2.</li> <li>Set sprayer to OFF and disconnect power to sprayer.</li> <li>Disconnect motor connector(s) from control board socket(s). Check that motor connector and control board contacts are clean and secure. If contacts are clean and secure, continue to step 4.</li> <li>Set sprayer to OFF and spin motor fan 1/2 turn. Restart sprayer. If sprayer runs, replace control board. If sprayer does not run, continue to step 5.</li> <li><b>Perform Spin Test:</b> Test at large 4-pin motor field connector. Disconnect fluid pump from sprayer. Test motor by placing a jumper across pins 1 &amp; 2. Rotate motor fan at about 2 revolutions per second. A cogging resistance to motion should be felt at the fan. The motor should be replaced if no resistance is felt. Repeat for pin combinations 1 &amp; 3 and 2 &amp; 3. Pin 4 (the green wire) is not used in this test. If all spin test is positive, continue to step 6.</li> </ol> 

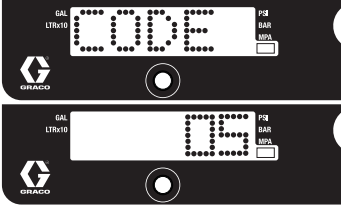
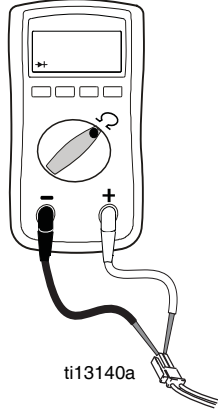
TYPE OF PROBLEM	WHAT TO CHECK	HOW TO CHECK												
<p>Sprayer does not run at all</p> <p>Display shows CODE 05</p> 	<p>Control is commanding motor to run but motor shaft does not rotate. Possibly locked rotor condition, an open connection exists between motor and control, there is a problem with motor or control board, or motor amp draw is excessive.</p>	<p>6. <b>Perform Field Short Test:</b> Test at large 4-pin motor field connector. There should not be continuity from pin 4, the ground wire, and any of the remaining 3 pins. If motor field connector tests fail, replace motor.</p> <p>7. <b>Check Motor Thermal Switch:</b> Unplug thermal wires. Set meter to ohms. Meter should read the proper resistance for each unit (see table below).</p>												
<p>Control board status light blinks 5 times repeatedly</p>		 <p>ti13140a</p> <table border="1" data-bbox="880 1031 1349 1228"> <thead> <tr> <th colspan="2">Resistance Table:</th> </tr> </thead> <tbody> <tr> <td>695/240V Mark IV</td> <td>0 ohms</td> </tr> <tr> <td>795/120V Mark IV</td> <td>2k ohms</td> </tr> <tr> <td>1095/240V Mark V</td> <td>3.9k ohms</td> </tr> <tr> <td>1595/120V Mark V/MARK VII</td> <td>6.2k ohms</td> </tr> <tr> <td>MARK X</td> <td>10.0k ohms</td> </tr> </tbody> </table>	Resistance Table:		695/240V Mark IV	0 ohms	795/120V Mark IV	2k ohms	1095/240V Mark V	3.9k ohms	1595/120V Mark V/MARK VII	6.2k ohms	MARK X	10.0k ohms
Resistance Table:														
695/240V Mark IV	0 ohms													
795/120V Mark IV	2k ohms													
1095/240V Mark V	3.9k ohms													
1595/120V Mark V/MARK VII	6.2k ohms													
MARK X	10.0k ohms													

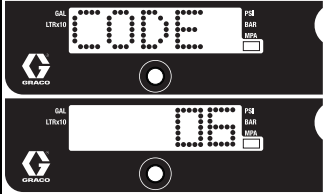
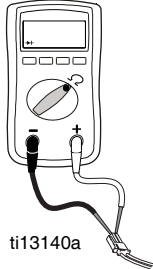
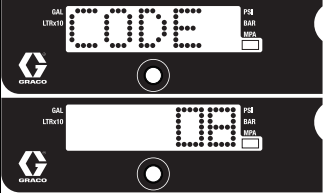
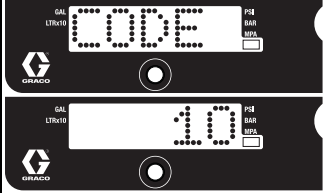
TYPE OF PROBLEM	WHAT TO CHECK	HOW TO CHECK												
<p>Sprayer does not run at all</p> <p>Display shows CODE 06</p>  <p>Control board status light blinks 6 times repeatedly</p>	<p>Allow sprayer to cool. If sprayer runs when cool, correct cause of overheating. Keep sprayer in cooler location with good ventilation. Make sure motor air intake is not blocked. If sprayer still does not run, follow Step 1.</p>	<p><b>NOTE:</b> Motor must be cooled down for the test.</p> <ol style="list-style-type: none"> <li>1. Check thermal device connector (yellow wires) at control board.</li> <li>2. Disconnect thermal device connector from control board socket. Make sure contacts are clean and secure. Measure resistance of the thermal device. If reading is not correct, replace motor.</li> </ol> <p><b>Check Motor Thermal Switch:</b> Unplug thermal wires. Set meter to ohms. Meter should read the proper resistance for each unit (see table below).</p>  <p>ti13140a</p> <table border="1" data-bbox="979 871 1446 1071"> <thead> <tr> <th colspan="2">Resistance Table:</th> </tr> </thead> <tbody> <tr> <td>695/240V Mark IV</td> <td>0 ohms</td> </tr> <tr> <td>795/120V Mark IV</td> <td>2k ohms</td> </tr> <tr> <td>1095/240V Mark V</td> <td>3.9k ohms</td> </tr> <tr> <td>1595/120V Mark V/MARK VII</td> <td>6.2k ohms</td> </tr> <tr> <td>MARK X</td> <td>10.0k ohms</td> </tr> </tbody> </table> <ol style="list-style-type: none"> <li>3. Reconnect thermal device connector to control board socket. Connect power, turn sprayer ON and control knob 1/2 turn clockwise. If sprayer does not run, replace control board.</li> </ol>	Resistance Table:		695/240V Mark IV	0 ohms	795/120V Mark IV	2k ohms	1095/240V Mark V	3.9k ohms	1595/120V Mark V/MARK VII	6.2k ohms	MARK X	10.0k ohms
Resistance Table:														
695/240V Mark IV	0 ohms													
795/120V Mark IV	2k ohms													
1095/240V Mark V	3.9k ohms													
1595/120V Mark V/MARK VII	6.2k ohms													
MARK X	10.0k ohms													
<p>Sprayer does not run at all</p> <p>Display shows CODE 08</p>  <p>Control board status light blinks eight times repeatedly</p>	<p>Check voltage supply to the sprayer (incoming voltage too low for sprayer operation)</p>	<ol style="list-style-type: none"> <li>1. Set sprayer to OFF and disconnect power to sprayer.</li> <li>2. Remove other equipment that uses the same circuit.</li> <li>3. Locate a good voltage supply to avoid damage to electronics.</li> </ol>												
<p>Sprayer does not run at all</p> <p>Display shows CODE 10</p>  <p>Control board status light blinks 10 times repeatedly</p>	<p>Check to see if control board is over heating.</p>	<ol style="list-style-type: none"> <li>1. Make sure motor air intake is not blocked.</li> <li>2. Make sure fan has not failed.</li> <li>3. Make sure control board is properly connected to back plate and that conductive thermal paste is used on power components.</li> <li>4. Replace control board.</li> <li>5. Replace motor.</li> </ol>												

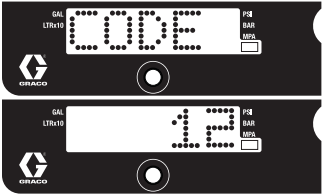
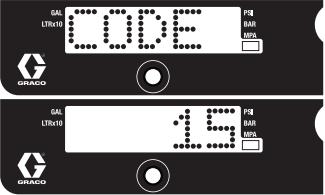
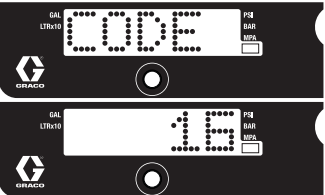
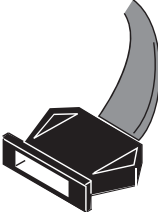
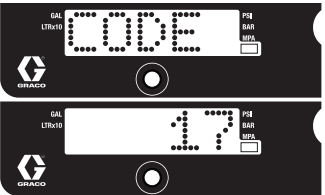
TYPE OF PROBLEM	WHAT TO CHECK	HOW TO CHECK
Sprayer does not run at all Display shows CODE 12  Control board status light blinks 12 times repeatedly	Excessive current protection enabled	1. Cycle power on and off.
Sprayer does not run at all Display shows CODE 15  Control board status light blinks 15 times repeatedly	Check the connections above the motor	1. Set sprayer to OFF and disconnect power to sprayer. 2. Remove motor shroud. 3. Disconnect motor control and inspect for damage at connectors. 4. Reconnect motor control. 5. Turn power on. If code continues, replace motor.
Sprayer does not run at all Digital display shows CODE 16  Control board status light blinks 16 times repeatedly	Check the connections. Control is not receiving a motor position sensor signal	1. Turn power OFF. 2. Disconnect motor position sensor and inspect for damage at connectors.  ti18685a 3. Reconnect sensor. 4. Turn power ON. If code continues, replace motor.
Sprayer does not run at all Display shows CODE 17  Control board status light blinks 17 times repeatedly	Check voltage supply to the sprayer (sprayer plugged into wrong voltage)	1. Set sprayer to OFF and disconnect power to sprayer. 2. Locate a good voltage supply to avoid damage to electronics.



### Sprayer Will Not Run

(See following page for steps)

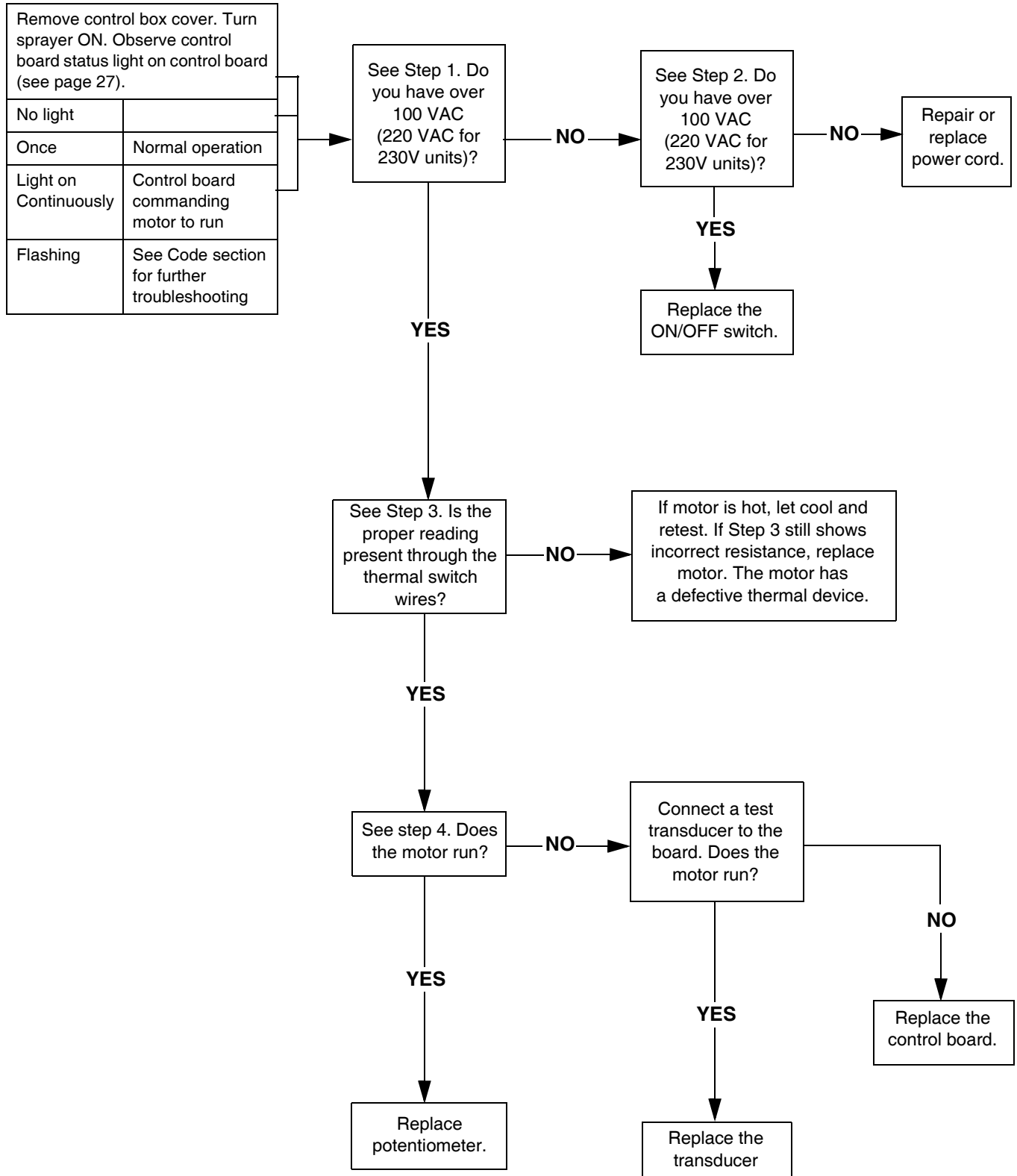

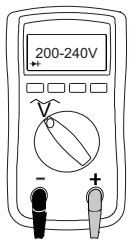

**STEP 1:**  
 Plug power cord in  
 and turn switch ON.  
 Connect probes to  
 on/off switch. Turn  
 meter to AC Volts.

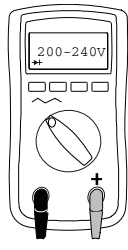

**STEP 2:**  
 Plug power cord in  
 and turn switch ON.  
 Connect probes to  
 on/off switch. Turn  
 meter to AC Volts.

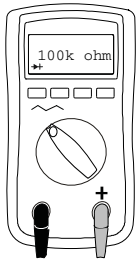
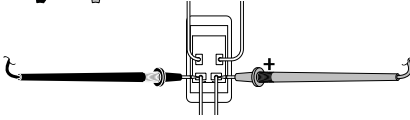
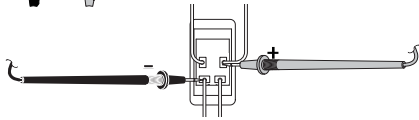

**STEP 3:**  
 Check motor thermal switch.  
 Unplug yellow wires. Meter  
 should read according to  
 Resistance Table on page 30.  
**NOTE:** Motor should be cool  
 during reading.

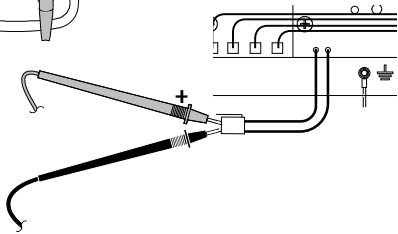

**STEP 4:**  
 Plug power cord  
 in and turn switch  
 ON. Disconnect  
 potentiometer.

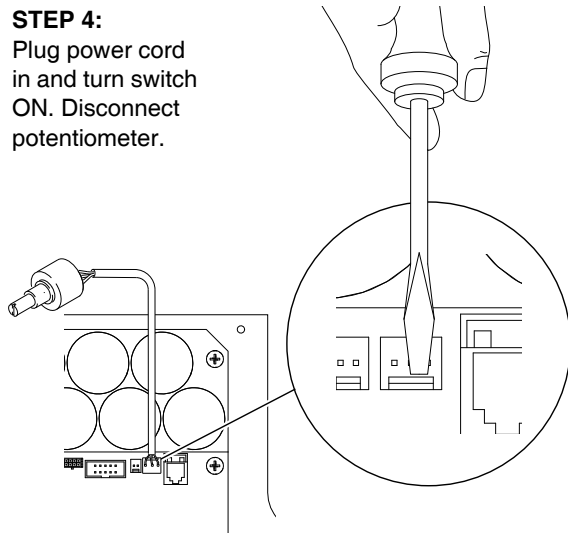

## Sprayer Will Not Shut Off

1. Perform **Pressure Relief Procedure**; page 13.  
Leave prime valve open and power switch OFF.
2. Remove control box cover so the control board status light can be viewed if available.

### Troubleshooting Procedure

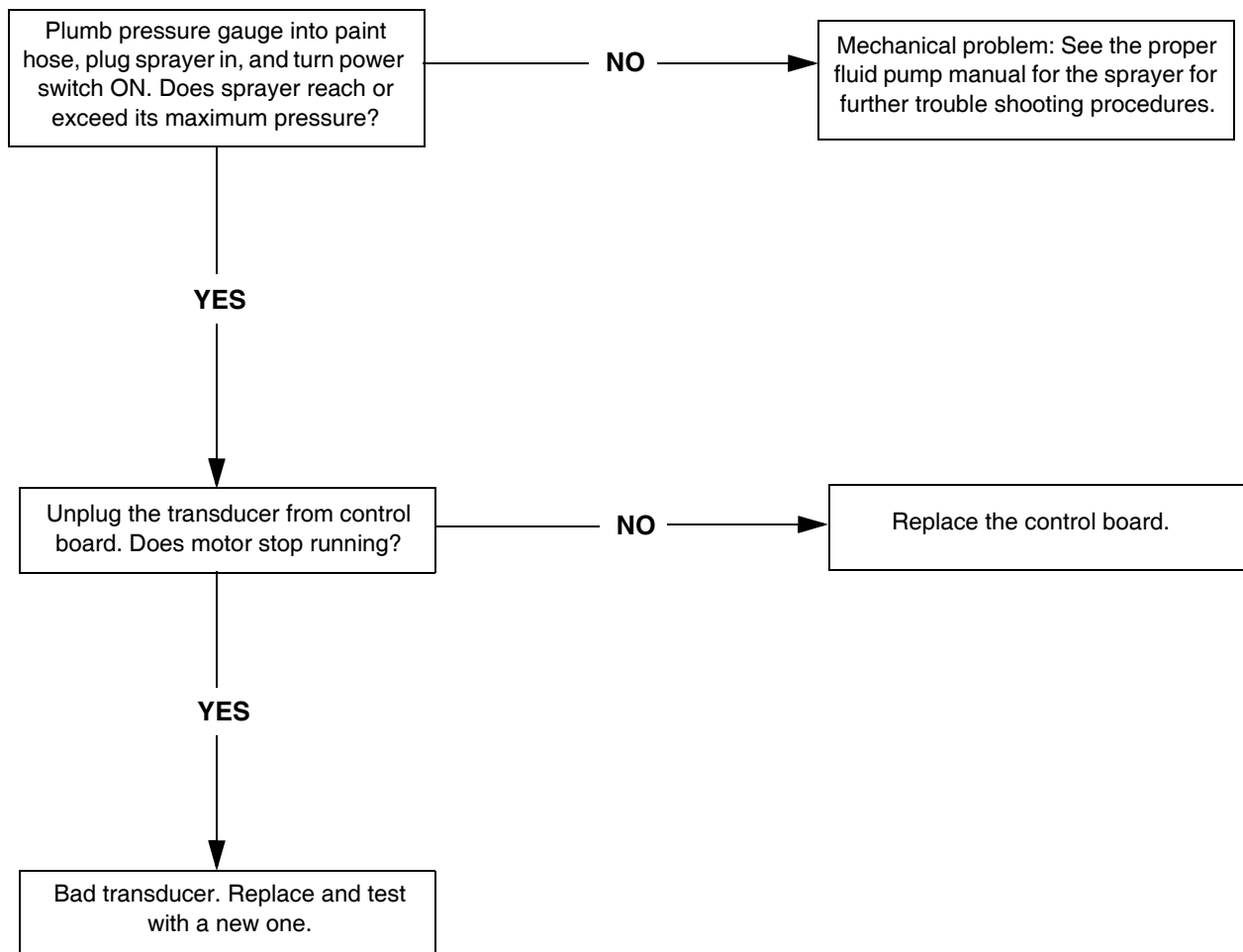

# Technical Data

<b>695 Sprayers</b>		
	<b>U.S.</b>	<b>Metric</b>
<b>Sprayer</b>		
Maximum Delivery		
North American Models	0.95 gpm	3.6 lpm
International Models	0.75 gpm	2.8 lpm
Maximum Tip Size	0.031	0.031
Fluid Outlet npsm	1/4 in.	1/4 in.
Cycles	226 per gallon	60 per liter
Generator Minimum	5000 W	5000 W
120V, A, Hz	14.8, 50/60	14.8, 8, 50/60
230V, A, Hz	9, 50/60	9, 50/60
<b>Dimensions</b>		
Weight:		
Standard Series Lo-Boy	94 lb	43 kg
Standard Series Hi-Boy	94 lb	43 kg
ProContractor	111 lb	50 kg
Height:		
Standard Series Lo-Boy	27.5 in.	69.9 cm
Standard Series Hi-Boy	28.5 in. (Handle down) 38.75 in. (Handle up)	72.4 cm (Handle down) 98.4 cm (Handle up)
ProContractor	39 in.	99 cm
Length:		
Standard Series Lo-Boy	37 in.	94 cm
Standard Series Hi-Boy	26 in.	66 cm
ProContractor	29.5 in.	75 cm
Width:	22.5 in.	57.2 cm
Wetted parts		
	zinc- and nickel-plated carbon steel, nylon, stainless steel, PTFE, Acetal, leather, UHMWPE, aluminum, tungsten carbide, PEEK, brass	
Noise Level:		
Sound Power	91 dBa*	91 dBa*
Sound Pressure	82 dBa*	82 dBa*
	*per ISO 3744; measured at 3.1 ft	*per ISO 3744; measured at 1 m

<b>795 Sprayers</b>		
	<b>U.S.</b>	<b>Metric</b>
<b>Sprayer</b>		
Maximum Delivery		
North American Models	1.1 gpm	4.2 lpm
International Models	0.95 gpm	3.6 lpm
Maximum Tip Size	0.033	0.033
Fluid Outlet npsm	1/4 in.	1/4 in.
Cycles	195 per gallon	52 per liter
Generator Minimum	5000 W	5000 W
120V, A, Hz	15, 50/60	15, 50/60
230V, A, Hz	10, 50/60	10, 50/60
<b>Dimensions</b>		
Weight:		
Standard Series Lo-Boy	98 lb	45 kg
Standard Series Hi-Boy	98 lb	45 kg
ProContractor	115 lb	52 kg
Height:		
Standard Series Lo-Boy	27.5 in.	69.9 cm
Standard Series Hi-Boy	28.5 in. (Handle down) 38.75 in. (Handle up)	72.4 cm (Handle down) 98.4 cm (Handle up)
ProContractor	39 in.	99 cm
Length:		
Standard Series Lo-Boy	37 in.	94 cm
Standard Series Hi-Boy	26 in.	66 cm
ProContractor	29.5 in.	75 cm
Width:	22.5 in.	57.2 cm
Wetted parts		
	zinc- and nickel-plated carbon steel, nylon, stainless steel, PTFE, Acetal, leather, UHMWPE, aluminum, tungsten carbide, PEEK, brass	
Noise Level:		
Sound Power	91 dBa*	91 dBa*
Sound Pressure	82 dBa*	82 dBa*
	*per ISO 3744; measured at 3.1 ft	*per ISO 3744; measured at 1 m

<b>1095 Sprayers</b>		
	<b>U.S.</b>	<b>Metric</b>
<b>Sprayer</b>		
Maximum Delivery		
North American Models	1.2 gpm	4.5 lpm
International Models	1.1 gpm	4.1 lpm
Maximum Tip Size	0.035	0.035
Fluid Outlet npsm	1/4 in.	1/4 in.
Cycles	123 per gallon	33 per liter
Generator Minimum	5000 W	5000 W
120V, A, Hz	15, 50/60	15, 50/60
230V, A, Hz	10, 50/60	10, 50/60
<b>Dimensions</b>		
Weight:		
Standard Series Hi-Boy	120 lb	55 kg
ProContractor	141 lb	64 kg
IronMan	127 lb	58 kg
Height:		
Standard Series Hi-Boy	29.5 in. (Handle down) 38.5 in. (Handle up)	74.9 cm (Handle down) 97.8 cm (Handle up)
ProContractor	39 in.	99 cm
IronMan	40.2 in.	102 cm
Length:		
Standard Series Hi-Boy	26 in.	66 cm
ProContractor	28 in.	71 cm
IronMan	29.9 in.	76 cm
Width:		
Standard Series Hi-Boy	24 in.	61 cm
ProContractor	24 in.	61 cm
IronMan	24.4 in.	62 cm
Wetted parts		
	zinc- and nickel-plated carbon steel, nylon, stainless steel, PTFE, Acetal, leather, UHMWPE, aluminum, tungsten carbide, PEEK, brass	
Noise Level:		
Sound Power	91 dBa*	91 dBa*
Sound Pressure	82 dBa*	82 dBa*
	*per ISO 3744; measured at 3.1 ft	*per ISO 3744; measured at 1 m

<b>1595 Sprayers</b>		
	<b>U.S.</b>	<b>Metric</b>
<b>Sprayer</b>		
Maximum Delivery	1.35 gpm	5.1 lpm
Maximum Tip Size	0.039	0.039
Fluid Outlet npsm	1/4 in.	1/4 in.
Cycles	110 per gallon	29 per liter
Generator Minimum	5000 W	5000 W
120V, A, Hz	20/15, 50/60	20/15, 50/60
<b>Dimensions</b>		
Weight:		
Standard Series Hi-Boy	125 lb	57 kg
ProContractor	146 lb	66 kg
IronMan	132 lb	60 kg
Height:		
Standard Series Hi-Boy	29.5 in. (Handle down) 38.5 in. (Handle up)	74.9 cm (Handle down) 97.8 cm (Handle up)
ProContractor	39 in.	99 cm
IronMan	40.2 in.	102 cm
Length:		
Standard Series Hi-Boy	26 in.	66 cm
ProContractor	28 in.	71 cm
IronMan	29.9 in.	76 cm
Width:		
Standard Series Hi-Boy	24 in.	61 cm
ProContractor	24 in.	61 cm
IronMan	24.4 in.	62 cm
Wetted parts		
	zinc- and nickel-plated carbon steel, nylon, stainless steel, PTFE, Acetal, leather, UHMWPE, aluminum, tungsten carbide, PEEK, brass	
Noise Level:		
Sound Power	91 dBa*	91 dBa*
Sound Pressure	82 dBa*	82 dBa*
	*per ISO 3744; measured at 3.1 ft	*per ISO 3744; measured at 1 m

<b>Mark IV Sprayers</b>		
	<b>U.S.</b>	<b>Metric</b>
<b>Sprayer</b>		
Maximum Delivery		
North American Models	1.1 gpm	4.2 lpm
International Models	0.95 gpm	3.6 lpm
Maximum Tip Size		
North American Models	0.033	0.033
International Models	0.031	0.031
Fluid Outlet npsm	3/8 in.	3/8 in.
Cycles	195 per gallon	52 per liter
Generator Minimum	5000 W	5000 W
120V, A, Hz	15, 50/60	15, 50/60
230V, A, Hz	10, 50/60	10, 50/60
<b>Dimensions</b>		
Weight:		
Standard Series Hi-Boy	98 lb	45 kg
ProContractor	119 lb	54 kg
Height:		
Standard Series Hi-Boy	28.5 in. (Handle down) 38.75 in. (Handle up)	72.4 cm (Handle down) 98.4 cm (Handle up)
ProContractor	39 in.	99 cm
Length:		
Standard Series Hi-Boy	26 in.	66 cm
ProContractor	29.5 in.	75 cm
Width:	22.5 in.	57.2 cm
Wetted parts		
	zinc- and nickel-plated carbon steel, nylon, stainless steel, PTFE, Acetal, leather, UHMWPE, aluminum, tungsten carbide, PEEK, brass	
Noise Level:		
Sound Power	91 dBa*	91 dBa*
Sound Pressure	82 dBa*	82 dBa*
	*per ISO 3744; measured at 3.1 ft	*per ISO 3744; measured at 1 m



<b>Mark V Sprayers</b>		
	<b>U.S.</b>	<b>Metric</b>
<b>Sprayer</b>		
Maximum Delivery		
North American and UK Models	1.35 gpm	5.1 lpm
International Models	1.2 gpm	4.5 lpm
Maximum Tip Size		
North American and UK Models	0.039	0.039
International Models	0.035	0.035
Fluid Outlet npsm	3/8 in.	3/8 in.
Cycles	110 per gallon	29 per liter
Generator Minimum	5000 W	5000 W
120V, A, Hz	20/15, 50/60	20/15, 50/60
230V, A, Hz	10, 50/60	10, 50/60
<b>Dimensions</b>		
Weight:		
Standard Series Hi-Boy	130 lb	59 kg
ProContractor	151 lb	68 kg
IronMan	137 lb	62 kg
Height:		
Standard Series Hi-Boy	29.5 in. (Handle down) 38.5 in. (Handle up)	74.9 cm (Handle down) 97.8 cm (Handle up)
ProContractor	39 in.	99 cm
IronMan	40.2 in.	102 cm
Length:		
Standard Series Hi-Boy	26 in.	66 cm
ProContractor	28 in.	71 cm
IronMan	29.9 in.	76 cm
Width:		
Standard Series Hi-Boy	24 in.	61 cm
ProContractor	24 in.	61 cm
IronMan	24.4 in.	62 cm
<b>Wetted parts</b>		
	zinc- and nickel-plated carbon steel, nylon, stainless steel, PTFE, Acetal, leather, UHMWPE, aluminum, tungsten carbide, PEEK, brass	
<b>Noise Level:</b>		
Sound Power	91 dBa*	91 dBa*
Sound Pressure	82 dBa*	82 dBa*
	*per ISO 3744; measured at 3.1 ft	*per ISO 3744; measured at 1 m

<b>Mark VII Sprayers</b>		
	<b>U.S.</b>	<b>Metric</b>
<b>Sprayer</b>		
Maximum Delivery	1.58 gpm	6.0 lpm
Maximum Tip Size	0.041 in.	0.041 in.
Fluid Outlet npsm	1/2 in.	1/2 in.
Cycles	97 per gallon	26 per liter
Generator Minimum	5000 W	5000 W
230V, A, Hz	16, 50/60	16, 50/60
<b>Dimensions</b>		
Weight:		
Standard Series Hi-Boy	139 lb	63 kg
ProContractor	160 lb	73 kg
Height:		
Standard Series Hi-Boy	29.5 in. (Handle down) 38.5 in. (Handle up)	74.9 cm (Handle down) 97.8 cm (Handle up)
ProContractor	39 in.	99 cm
Length:		
Standard Series Hi-Boy	26 in.	66 cm
ProContractor	28 in.	71 cm
Width:		
	24 in.	61 cm
Wetted parts		
	zinc- and nickel-plated carbon steel, nylon, stainless steel, PTFE, Acetal, leather, UHMWPE, aluminum, tungsten carbide, PEEK, brass	
Noise Level:		
Sound Power	91 dBa*	91 dBa*
Sound Pressure	82 dBa*	82 dBa*
	*per ISO 3744; measured at 3.1 ft	*per ISO 3744; measured at 1 m

<b>Mark X Sprayers</b>		
	<b>U.S.</b>	<b>Metric</b>
<b>Sprayer</b>		
Maximum Delivery	2.1 gpm	8.0 lpm
Maximum Tip Size	0.045 in.	0.045 in.
Fluid Outlet npsm	1/2 in.	1/2 in.
Cycles	70 per gallon	19 per liter
Generator Minimum	5000 W	5000 W
230V, A, Hz	16, 50/60	
<b>Dimensions</b>		
Weight:		
Standard Series Hi-Boy	154 lb	70 kg
ProContractor	178 lb	81 kg
Height:		
Standard Series Hi-Boy	29.9 in. (Handle down) 40.1 in. (Handle up)	76 cm (Handle down) 102 cm (Handle up)
ProContractor	39 in.	99 cm
Length:		
Standard Series Hi-Boy	26 in.	66 cm
ProContractor	30 in.	75 cm
Width:	24 in.	61 cm
Wetted parts		
	zinc- and nickel-plated carbon steel, nylon, stainless steel, PTFE, Acetal, leather, UHMWPE, aluminum, tungsten carbide, PEEK, brass	
Noise Level:		
Sound Power	91 dBa*	91 dBa*
Sound Pressure	82 dBa*	82 dBa*
	*per ISO 3744; measured at 3.1 ft	*per ISO 3744; measured at 1 m

# Graco Standard Warranty

Graco warrants all equipment referenced in this document which is manufactured by Graco and bearing its name to be free from defects in material and workmanship on the date of sale to the original purchaser for use. With the exception of any special, extended, or limited warranty published by Graco, Graco will, for a period of twelve months from the date of sale, repair or replace any part of the equipment determined by Graco to be defective. This warranty applies only when the equipment is installed, operated and maintained in accordance with Graco's written recommendations.

This warranty does not cover, and Graco shall not be liable for general wear and tear, or any malfunction, damage or wear caused by faulty installation, misapplication, abrasion, corrosion, inadequate or improper maintenance, negligence, accident, tampering, or substitution of non-Graco component parts. Nor shall Graco be liable for malfunction, damage or wear caused by the incompatibility of Graco equipment with structures, accessories, equipment or materials not supplied by Graco, or the improper design, manufacture, installation, operation or maintenance of structures, accessories, equipment or materials not supplied by Graco.

This warranty is conditioned upon the prepaid return of the equipment claimed to be defective to an authorized Graco distributor for verification of the claimed defect. If the claimed defect is verified, Graco will repair or replace free of charge any defective parts. The equipment will be returned to the original purchaser transportation prepaid. If inspection of the equipment does not disclose any defect in material or workmanship, repairs will be made at a reasonable charge, which charges may include the costs of parts, labor, and transportation.

**THIS WARRANTY IS EXCLUSIVE, AND IS IN LIEU OF ANY OTHER WARRANTIES, EXPRESS OR IMPLIED, INCLUDING BUT NOT LIMITED TO WARRANTY OF MERCHANTABILITY OR WARRANTY OF FITNESS FOR A PARTICULAR PURPOSE.**

Graco's sole obligation and buyer's sole remedy for any breach of warranty shall be as set forth above. The buyer agrees that no other remedy (including, but not limited to, incidental or consequential damages for lost profits, lost sales, injury to person or property, or any other incidental or consequential loss) shall be available. Any action for breach of warranty must be brought within two (2) years of the date of sale.

**GRACO MAKES NO WARRANTY, AND DISCLAIMS ALL IMPLIED WARRANTIES OF MERCHANTABILITY AND FITNESS FOR A PARTICULAR PURPOSE, IN CONNECTION WITH ACCESSORIES, EQUIPMENT, MATERIALS OR COMPONENTS SOLD BUT NOT MANUFACTURED BY GRACO.** These items sold, but not manufactured by Graco (such as electric motors, switches, hose, etc.), are subject to the warranty, if any, of their manufacturer. Graco will provide purchaser with reasonable assistance in making any claim for breach of these warranties.

In no event will Graco be liable for indirect, incidental, special or consequential damages resulting from Graco supplying equipment hereunder, or the furnishing, performance, or use of any products or other goods sold hereto, whether due to a breach of contract, breach of warranty, the negligence of Graco, or otherwise.

## **FOR GRACO CANADA CUSTOMERS**

The Parties acknowledge that they have required that the present document, as well as all documents, notices and legal proceedings entered into, given or instituted pursuant hereto or relating directly or indirectly hereto, be drawn up in English. Les parties reconnaissent avoir convenu que la rédaction du présente document sera en Anglais, ainsi que tous documents, avis et procédures judiciaires exécutés, donnés ou intentés, à la suite de ou en rapport, directement ou indirectement, avec les procédures concernées.

# Graco Information

For the latest information about Graco products, visit [www.graco.com](http://www.graco.com).

For patent information, see [www.graco.com/patents](http://www.graco.com/patents).

**TO PLACE AN ORDER**, contact your Graco distributor or call 1-800-690-2894 to identify the nearest distributor.

*All written and visual data contained in this document reflects the latest product information available at the time of publication.  
Graco reserves the right to make changes at any time without notice.*

Original instructions. This manual contains English. MM 332916

**Graco Headquarters:** Minneapolis  
**International Offices:** Belgium, China, Japan, Korea

**GRACO INC. AND SUBSIDIARIES • P.O. BOX 1441 • MINNEAPOLIS MN 55440-1441 • USA**

**Copyright 2014, Graco Inc. All Graco manufacturing locations are registered to ISO 9001.**

[www.graco.com](http://www.graco.com)  
Revision D -July 2015