

112 Wet Film Combs

en

Elcometer

112 • 115 • 154 • 3230 • 3236 • 3238

Wet Film Combs and Wheel

Operating Instructions

en elcometer®

elcometer® is a registered trademark of Elcometer Limited.
All other trademarks acknowledged.

© Copyright Elcometer Limited. 2008-2015.

All rights reserved. No part of this Document may be reproduced, transmitted, transcribed, stored (in a retrieval system or otherwise) or translated into any language, in any form or by any means (electronic, mechanical, magnetic, optical, manual or otherwise) without the prior written permission of Elcometer Limited.

A copy of this Instruction Manual is available for download on our Website via www.elcometer.com

*Doc.No. TMA-0365 Issue 08
Text with Cover No: 19811*

CONTENTS

Section	Page
1 About this gauge	2
2 Using a Wet Film Comb	5
3 Using a Wet Film Wheel	6
4 Cleaning after a test	7
5 Maintenance	7
6 Technical specification	7
7 Elcometer Wet Film Combs	8
8 Elcometer Wet Film Wheels	9
9 Wet Film Wheel accessories	10
10 Related equipment	10

Elcometer 112

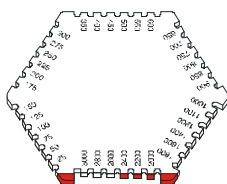

Elcometer 115



Elcometer 154

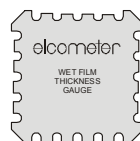

Elcometer 3230

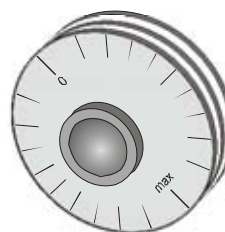

Elcometer 3236

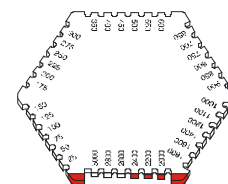

Elcometer 3238

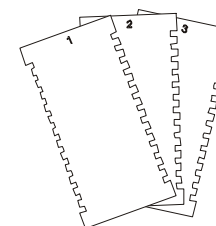

en elcometer

Thank you for your purchase of this Elcometer Wet Film Comb/Wheel. Welcome to Elcometer.

Elcometer are world leaders in the design, manufacture and supply of inspection equipment for coatings and concrete. Our products cover all aspects of coating inspection, from development through application to post application inspection.

With the purchase of this product you now have access to the worldwide service and support network of Elcometer. For more information visit our website at www.elcometer.com

1 ABOUT THIS GAUGE

This gauge is a simple but effective instrument used to determine the thickness of wet paints and similar coatings immediately after application. The expected dry film thickness can then be calculated.

1.1 WET FILM COMBS

The edge of the comb is placed into the wet film and then removed. The thickness of the wet film is determined by examining the paint left on the teeth of the comb and the thickness scale marked on the front face of the comb.

Elcometer 112 & Elcometer 3236

Precision formed in stainless steel to be long-lasting and reusable, these hexagonal wet film combs are supplied in a range of thicknesses up to a maximum of 3000 μm (120 mils). This high upper value allows measurement of thick coatings which are difficult to test by other methods. An aluminium version is available (Elcometer 112AL); this model is not as accurate as the high precision versions but it does provide a low cost alternative for measurement of wet film thickness.

2

elcometer® **US****Elcometer 115**

These precision film combs, formed in stainless steel to be long-lasting and reusable, are supplied in Metric or Imperial values. Four separate ranges of thicknesses are available up to a maximum thickness of 1250 μm (50 mils). Each comb has 10 measurements (or teeth) per comb.

Elcometer 154

Made from ABS plastic, the Elcometer 154 Wet Film Combs are designed to be used only once and kept as a record of wet film thickness measurement for your ISO or customer requirements. Both Metric and Imperial values are on the same comb, 50 to 800 μm on one side, 2 to 32 mils on the other.

Elcometer 3238

Similar to the Elcometer 115, the Elcometer 3238 provides the user with more measurement points (teeth). These rectangular wet film combs are available in 3 ranges up to a maximum thickness of 1200 μm (50 mils) - supplied either separately or in a set of 3.

1.2 WET FILM WHEEL**Elcometer 3230**

Formerly known as the Elcometer 120, the Elcometer 3230 wet film wheel consists of a central eccentric wheel and two outer concentric wheels. The diameter of the outer wheels is greater than that of the central wheel. The gauge is rolled across the wet paint film and at some point the central wheel will touch the paint. A scale on the outside of the wheel indicates the paint film thickness at this point. Various measurement ranges from 0 to 25 μm to 0 to 1000 μm (0 to 1 mil - 0 to 40 mils) are available.

Coil Coating Wet Film Wheel; similar to the Elcometer 3230 wet film wheels, but the outer wheels are knurled to allow measurements to be taken on slippery coatings or on fast moving substrates.

3

en elcometer

1.3 STANDARDS

Your Elcometer Wet Film Comb/Wheel can be used in accordance with the following National and International Standards (depending upon model).

Standard	Elcometer Models					
	112	115	154	3230	3236	3238
AS/NZS 1580.107.3	✓	✓	-	✓	✓	✓
ASTM D 1212-A	-	-	-	✓	-	-
ASTM D 4414-A	✓	✓	-	-	✓	✓
ISO 2808-1A supersedes BS 3900-C5-7B, ISO 2808-7B	✓	✓	✓	-	✓	✓
ISO 2808-1B supersedes BS 3900-C5-7A	-	-	-	✓	-	-
NF T30-125	✓	✓	✓	✓	✓	✓
US Navy NSI 009-32	✓	✓	-	-	✓	✓
US Navy PPI 63101-000	✓	✓	-	-	✓	✓

1.4 WHAT THE BOX CONTAINS (EXCEPT ELCOMETER 154 & 112AL)

- Elcometer Wet Film Comb/Wheel
- Storage case
- Operating instructions

4

elcometer® en

2 USING A WET FILM COMB

Before you start, ensure your Elcometer Wet Film Comb is clean and undamaged.

1. Hold the comb perpendicular to the wet film and press the edge of the comb into the film until it is stable on the substrate.
2. Remove the comb from the wet film.
3. Examine the teeth of the comb and locate the last tooth which is wetted. Read the thickness value of this tooth.

The wet film thickness is between this value and the thickness value of the next dry tooth.

In the example shown, the wet film thickness lies between 2400 μm and 2600 μm .

To use the comb on pipes, ensure it is placed parallel to the longitudinal axis of the pipe.

On rough surfaces, measurements will be made from the surface peaks and therefore will represent the minimum wet film thickness.

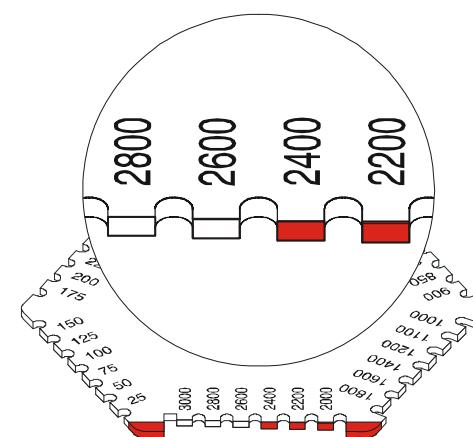
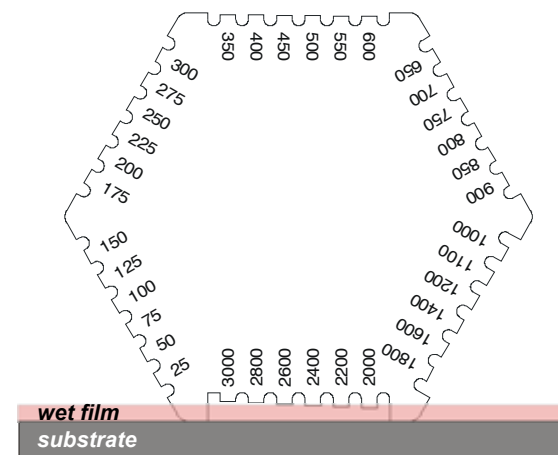

5

en elcometer

3 USING A WET FILM WHEEL

 Take care to avoid damaging your Elcometer Wet Film Wheel. Damage to the circumference of the wheel will affect the readings and the gauge will have to be replaced.

Before you start, ensure your Elcometer Wet Film Wheel is clean and undamaged. Read and understand the test procedure described in the applicable test standard.

The procedure depends upon which standard you are testing to. Consult your test standard for further details.

1. Using a finger and thumb, hold the wheel by its central spindle with the maximum reading on the scale nearest to the paint film.
2. Place the wheel into the wet film ensuring that the wheel is perpendicular to the film.
3. Roll the wheel across the film through 360°/180° (depending upon standard) and then remove from the surface.
4. Locate the first point on the central wheel where the paint has adhered. Read the wet film thickness from the scale on the side of the wheel at this point.

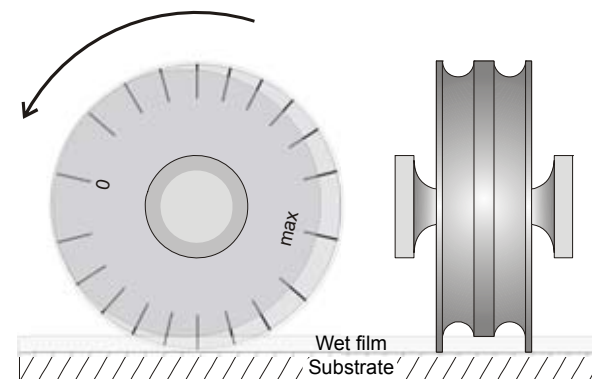

Repeat the procedure at least twice in different places to obtain representative results.

To use the wheel on pipes, roll the wheel at right angles to the longitudinal axis of the pipe.

On rough surfaces, measurements will be made from the surface peaks and therefore will represent the minimum wet film thickness.

6

4 CLEANING AFTER A TEST

Clean your gauge after a test (except Elcometer 154 Plastic Wet Film Comb).

✗ Do not use very aggressive solvents or wire brushes, metal scrapers, metal files or other metallic tools for cleaning.

✓ Clean the gauge using a suitable solvent only.

After cleaning, ensure that all materials are removed and that the gauge is dry.

Use the case provided to store the gauge when it is not being used.

5 MAINTENANCE

Elcometer products are designed to give many years reliable service under normal operating and storage conditions.

Regular calibration checks over the life of the gauge are a requirement of quality management procedures e.g. ISO 9000 and other standards. For checks and certification contact Elcometer or your local supplier.

6 TECHNICAL SPECIFICATION

Material:	Stainless steel, aluminium or plastic (depending upon model)
Accuracy - Model 112, 115, 3236, 3238:	± 5% or 2.5µm whichever is the greater
Accuracy - Model 3230:	± 5% of full scale dimension
Accuracy - Model 112AL, 154:	Nominal Values

Depending upon model, your Elcometer Wet Film Comb/Wheel may be packed in a cardboard and foam package. Please ensure that this packaging is disposed of in an environmentally sensitive manner. Consult your local Environmental Authority for further guidance.

en elcometer

7 ELCOMETER WET FILM COMBS

<i>Metric (microns)</i>			<i>Imperial (mils)</i>		
<i>Model</i>	<i>Scale (µm)</i>	<i>Part Number</i>	<i>Model</i>	<i>Scale (mils)</i>	<i>Part Number</i>
Elcometer 112:	25-3000	B112----1B	Elcometer 112:	1-120	B112----2B
Elcometer 112/AL: ^a	25-3000	B112AL12473-3	Elcometer 112/AL: ^a	1-118	B112AL12473-3
Elcometer 115:	20-325	B11529455M	Elcometer 115/1:	1-13	B11529451E
Elcometer 115:	50-450	B11529456M	Elcometer 115/2:	2-18	B11529452E
Elcometer 115:	50-750	B11529457M	Elcometer 115/3:	2-30	B11529453E
Elcometer 115:	125-1250	B11529458M	Elcometer 115/4:	5-50	B11529454E
Elcometer 115:	Metric Comb Set	B1152959WM	Elcometer 115:	Imperial Comb Set	B1152959WE
Elcometer 154: ^a	50-800	B154----1	Elcometer 154: ^a	2-32	B154----1
Elcometer 3236:	20-370	K0003236M201	Elcometer 3236:	0.5-15	K0US3236M203
Elcometer 3236:	25-2000	K0003236M202	Elcometer 3236:	1-80	K0US3236M204
Elcometer 3238:	5-120	K0003238M201	Elcometer 3238:	0.5-6	K0US3238M201
Elcometer 3238:	25-600	K0003238M202	Elcometer 3238:	1-24	K0US3238M202
Elcometer 3238:	50-1200	K0003238M203	Elcometer 3238:	2-48	K0US3238M203
Elcometer 3238:	Metric Comb Set	K0003238M204	Elcometer 3238:	Imperial Comb Set	K0US3238M204

a. These models have metric *and* imperial units - metric on one side, imperial on the other.

8 ELCOMETER WET FILM WHEELS

<i>Metric (microns)</i>			<i>Imperial (mils)</i>		
<i>Model</i>	<i>Scale (µm)</i>	<i>Part Number</i>	<i>Model</i>	<i>Scale (mils)</i>	<i>Part Number</i>
Elcometer 3230/1	0-25	K0003230M001	Elcometer 3230/1	0-1	K0US3230M001
Elcometer 3230/16	0-40	K0003230M016	Elcometer 3230/2	0-2	K0US3230M002
Elcometer 3230/2	0-50	K0003230M002	Elcometer 3230/3	0-4	K0US3230M003
Elcometer 3230/3	0-100	K0003230M003	Elcometer 3230/4	0-6	K0US3230M004
Elcometer 3230/4	0-150	K0003230M004	Elcometer 3230/5	0-12	K0US3230M005
Elcometer 3230/5	0-200	K0003230M005	Elcometer 3230/6	0-20	K0US3230M006
Elcometer 3230/6	0-250	K0003230M006	Elcometer 3230/7	0-40	K0US3230M007
Elcometer 3230/7	0-300	K0003230M007			
Elcometer 3230/8	0-400	K0003230M008			
Elcometer 3230/9	0-500	K0003230M009			
Elcometer 3230/10	0-1000	K0003230M010			
Elcometer 3230/17 ^a	0-50	K0003230M017	Elcometer 3230/17 ^a	0-2	K0US3230M017
Elcometer 3230/18 ^a	0-100	K0003230M018	Elcometer 3230/18 ^a	0-4	K0US3230M018

a. These models have knurled outer wheels for measurement on slippery coatings or fast moving substrates.

en elcometer

9 WET FILM WHEEL ACCESSORIES

Wet Film Wheel Handle, 15cm	KT003230N003
Wet Film Wheel Handle, 50cm	KT003230N002
Wet Film Wheel Handle, 100cm	KT003230N001

Note: Wet Film Wheel Handles are not compatible with the Elcometer 3230/17 and 3230/18.

10 RELATED EQUIPMENT

In addition to the Elcometer Wet Film Comb/Wheel, Elcometer produces a wide range of other coating testing equipment.

Users of the Elcometer Wet Film Comb/Wheel may also benefit from the following Elcometer products:

- Elcometer Surface Profile Gauges
- Elcometer Surface Cleanliness Test Kits
- Elcometer Climatic Condition Testers
- Elcometer Dry Coating Thickness Gauges

For further information contact Elcometer or your local supplier.

Details of Elcometer offices around the world are given on the outside cover of these operating instructions. Alternatively visit the Elcometer website, www.elcometer.com



10

elcometer®
www.elcometer.com

ENGLAND

Elcometer Limited
Edge Lane
Manchester M43 6BU
Tel: +44 (0)161 371 6000
Fax: +44 (0)161 371 6010
e-mail: sales@elcometer.com
www.elcometer.com

USA

Elcometer Inc
1893 Rochester Industrial Drive
Rochester Hills Michigan 48309
Tel: +1 248 650 0500
Toll Free: 800 521 0635
Fax: +1 248 650 0501
e-mail: inc@elcometer.com
www.elcometer.com

ASIA & THE FAR EAST

Elcometer (Asia) Pte Ltd
896 Dunearn Rd
Sime Darby Centre #03-09
Singapore 589472,
Tel: +65 6462 2822
Fax: +65 6462 2860
e-mail: asia@elcometer.com
www.elcometer.com

JAPAN

Elcometer KK
7F Toranomon MT40 Bldg. 5-13-1
Toranomon, Minato-ku
Tokyo 105-0001
Tel: +81 (0)3-4530-9714
Fax: +81 (0)3-4530-9713
email: jp_info@elcometer.com
www.elcometer.co.jp

BELGIUM

Elcometer SA
Rue Vallée 13
B-4681 Hermalle /s Argenteau
Tel: +32 (0)4 379 96 10
Fax: +32 (0)4 374 06 03
e-mail: be_info@elcometer.com
www.elcometer.be

FRANCE

Elcometer Sarl
97 Route de Chécy
45430 BOU
Tel: +33 (0)2 38 86 33 44
Fax: +33 (0)2 38 91 37 66
e-mail: fr_info@elcometer.com
www.elcometer.fr

GERMANY

Elcometer Instruments GmbH
Ulmer Strasse 68
D-73431 Aalen
Tel: +49(0)7361 52806 0
Fax: +49(0)7361 52806 77
e-mail: de_info@elcometer.de
www.elcometer.de

THE NETHERLANDS

Elcometer NL
Newtonlaan 115
3584 BH Utrecht
Tel: +31 (0)30 210.7005
Fax: +31 (0)30 210.6666
email: nl_info@elcometer.com
www.elcometer.com