

AirPro™ Pressure Feed Airspray Gun

312414P
EN

**Conventional, HVLP, and compliant guns for specialty industrial applications.
For professional use only.**

100 psi (0.7 MPa, 7 bar) Maximum Air Inlet Pressure

300 psi (2.1 MPa, 21 bar) Maximum Fluid Inlet Pressure



Important Safety Instructions

Read all warnings and instructions in this manual. Save these instructions.

See page 3 for model information.

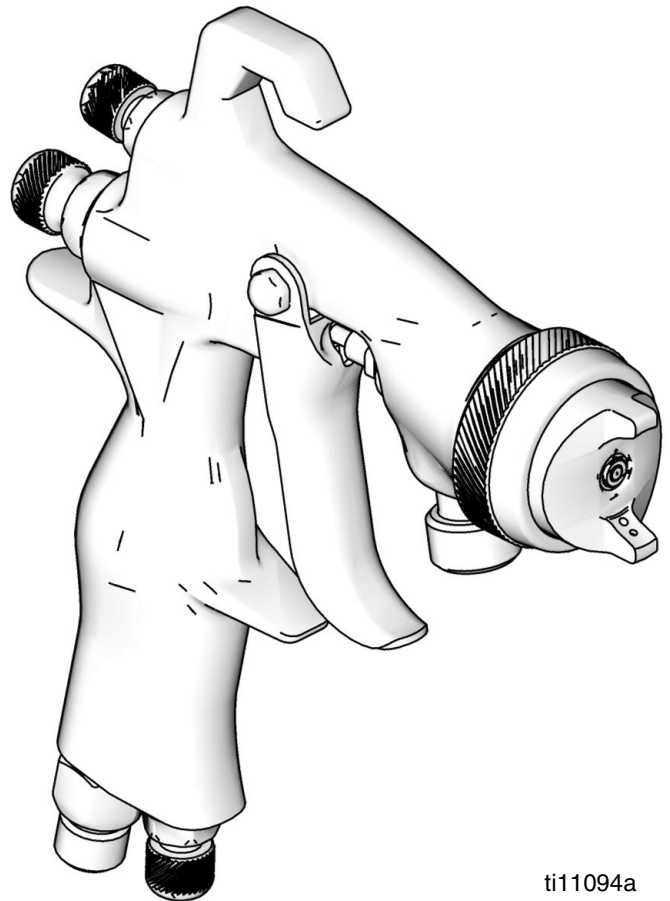

ti11094a



II 2 G

Contents

Models	3	Operation	9
General Metal Spray Guns	3	Pressure Relief Procedure	9
General Metal with Stainless Steel Tip	3	Apply Fluid	9
Automotive	3	Volatile Organic Compounds (VOC) Regulation .	9
Stain	4	Daily Gun Maintenance	10
Waterborne	4	General Tasks	10
High Wear	4	Flush	10
Adhesives	4	Clean Gun	11
Spatter Gun	4	Compliant Cleaning Methods	11
Air Brush	4	Troubleshooting	12
Warnings	5	Repair	14
Gun Selection	6	Disassembly	14
Conventional Guns	6	Reassembly	15
HVLP Guns	6	Parts	16
Compliant Guns	6	Accessories	19
Setup	7	Repair Kits	20
Connect Air and Fluid Lines	7	Technical Data	23
Ground the Gun	7	Graco Standard Warranty	24
Flush Before Using Equipment	7	Graco Information	24
Adjust Spray Pattern	8		

Models

Orifice Size in. (mm)	Conventional			HVLP			Compliant		
	Model	Series	Max. HVLP/Compliant Air Pressure psi (MPa, bar)	Model	Series	Max. HVLP/Compliant Air Pressure psi (MPa, bar)	Model	Series	Max. HVLP/Compliant Air Pressure psi (MPa, bar)
General Metal Spray Guns									
0.020 (0.5)	288726	A	N/A	288935	A	19 (0.13, 1.3)	288942	A	29 (0.2, 2.0)
0.030 (0.8)	288929	A	N/A	288936	A	19 (0.13, 1.3)	288943	A	29 (0.2, 2.0)
0.042 (1.1)	288930	A	N/A	288937	A	19 (0.13, 1.3)	288944	A	29 (0.2, 2.0)
0.055 (1.4)	288931	A	N/A	288938	A	19 (0.13, 1.3)	288945	A	29 (0.2, 2.0)
0.070 (1.8)	288932	A	N/A	288939	A	19 (0.13, 1.3)	288946	A	29 (0.2, 2.0)
0.086 (2.2)	288933	A	N/A	288940	A	19 (0.13, 1.3)	288947	A	29 (0.2, 2.0)
0.110 (2.8)	288934	A	N/A	288941	A	19 (0.13, 1.3)	288948	A	29 (0.2, 2.0)
General Metal with Stainless Steel Tip									
0.042 (1.1)	288949	A	N/A	288952	A	19 (0.13, 1.3)	288955	A	29 (0.2, 2.0)
0.055 (1.4)	288950	A	N/A	288953	A	19 (0.13, 1.3)	288956	A	29 (0.2, 2.0)
0.070 (1.8)	288951	A	N/A	288954	A	19 (0.13, 1.3)	288957	A	29 (0.2, 2.0)
0.042 (1.1)	24U187**	A	N/A						
0.055 (1.4)	24U188**	A	N/A						
Automotive									
0.030 (0.8)	288929	A	N/A	--	--	--	--	--	--
0.040 (1.0)	--	--	--	289034	A	29 (0.2, 2.0)	289036	A	35 (0.24, 2.4)
0.042 (1.1)	288930	A	N/A	--	--	--	--	--	--
0.042 (1.1)	24D472*	A	N/A	--	--	--	--	--	--
0.047 (1.2)	--	--	--	289035	A	29 (0.2, 2.0)	289037	A	35 (0.24, 2.4)
0.055 (1.4)	288931	A	N/A	289541	A	29 (0.2, 2.0)	289542	A	35 (0.24, 2.4)
* High production									
** Assembled for higher air flow volume.									

Orifice Size in. (mm)	Conventional			HVLP			Compliant		
	Model	Series	Max. HVLP/Compliant Air Pressure psi (MPa, bar)	Model	Series	Max. HVLP/Compliant Air Pressure psi (MPa, bar)	Model	Series	Max. HVLP/Compliant Air Pressure psi (MPa, bar)
Stain									
0.020 (0.5)	288958	A	N/A	288960	A	22 (0.15, 1.5)	288962	A	29 (0.2, 2.0)
0.030 (0.8)	288959	A	N/A	288961	A	22 (0.15, 1.5)	288963	A	29 (0.2, 2.0)
0.040 (1.0)	289109	A	N/A	289110	A	22 (0.15, 1.5)	289111	A	29 (0.2, 2.0)
Waterborne									
0.030 (0.8)	288964	A	N/A	288967	A	23 (0.16, 1.6)	288970	A	23 (0.16, 1.6)
0.042 (1.1)	288965	A	N/A	288968	A	23 (0.16, 1.6)	288971	A	23 (0.16, 1.6)
0.055 (1.4)	288966	A	N/A	288969	A	23 (0.16, 1.6)	288972	A	23 (0.16, 1.6)
High Wear									
0.059 (1.5)	288973	A	N/A	288976	A	20 (0.14, 1.4)	288979	A	29 (0.2, 2.0)
0.070 (1.8)	288974	A	N/A	288977	A	20 (0.14, 1.4)	288980	A	29 (0.2, 2.0)
0.086 (2.2)	288975	A	N/A	288978	A	20 (0.14, 1.4)	288981	A	29 (0.2, 2.0)
0.110 (2.8)	289982	A	N/A	289983	A	20 (0.14, 1.4)	289984	A	29 (0.2, 2.0)

Adhesives

Orifice Size in. (mm)	Conventional		
	Model	Series	Max. HVLP/Compliant Air Pressure psi (MPa, bar)
0.051 (1.3)	288982	A	N/A
0.070 (1.8)	288983	A	N/A

Air Brush



Orifice Size in. (mm)	Conventional		
	Model	Series	Max. HVLP/Compliant Air Pressure psi (MPa, bar)
0.042 (1.1)	24F202	A	N/A





Spatter Gun

Orifice Size in. (mm)	HVLP		
	Model	Series	Max. HVLP/Compliant Air Pressure psi (MPa, bar)
0.042 (1.1)	288985	A	30 (0.21, 2.1)

Warnings

The following warnings are for the setup, use, grounding, maintenance, and repair of this equipment. The exclamation point symbol alerts you to a general warning and the hazard symbol refers to procedure-specific risk. Refer back to these warnings. Additional, product-specific warnings may be found throughout the body of this manual where applicable.

 WARNING	
	<p>FIRE AND EXPLOSION HAZARD</p> <p>Flammable fumes, such as solvent and paint fumes, in work area can ignite or explode. To help prevent fire and explosion:</p> <ul style="list-style-type: none"> • Use equipment only in well ventilated area. • Eliminate all ignition sources; such as pilot lights, cigarettes, portable electric lamps, and plastic drop cloths (potential static arc). • Keep work area free of debris, including solvent, rags and gasoline. • Do not plug or unplug power cords or turn lights on or off when flammable fumes are present. • Ground all equipment in the work area. See Grounding instructions. • If there is static sparking or you feel a shock, stop operation immediately. Do not use equipment until you identify and correct the problem. • Keep a working fire extinguisher in the work area.
	<p>EQUIPMENT MISUSE HAZARD</p> <p>Misuse can cause death or serious injury.</p> <ul style="list-style-type: none"> • Do not operate the unit when fatigued or under the influence of drugs or alcohol. • Do not exceed the maximum working pressure or temperature rating of the lowest rated system component. See Technical Data in all equipment manuals. • Use fluids and solvents that are compatible with equipment wetted parts. See Technical Data in all equipment manuals. Read fluid and solvent manufacturer's warnings. For complete information about your material, request MSDS forms from distributor or retailer. • Check equipment daily. Repair or replace worn or damaged parts immediately with genuine manufacturer's replacement parts only. • Do not alter or modify equipment. • Use equipment only for its intended purpose. Call your distributor for information. • Route hoses and cables away from traffic areas, sharp edges, moving parts, and hot surfaces. • Do not kink or over bend hoses or use hoses to pull equipment. • Keep children and animals away from work area. • Comply with all applicable safety regulations.

 WARNING	
	<p>PRESSURIZED EQUIPMENT HAZARD</p> <p>Fluid from the gun/dispense valve, leaks, or ruptured components can splash in the eyes or on skin and cause serious injury.</p> <ul style="list-style-type: none"> • Follow Pressure Relief Procedure in this manual, when you stop spraying and before cleaning, checking, or servicing equipment. • Tighten all fluid connections before operating the equipment. • Check hoses, tubes, and couplings daily. Replace worn or damaged parts immediately.
	<p>TOXIC FLUID OR FUMES HAZARD</p> <p>Toxic fluids or fumes can cause serious injury or death if splashed in the eyes or on skin, inhaled, or swallowed.</p> <ul style="list-style-type: none"> • Read MSDS's to know the specific hazards of the fluids you are using. • Store hazardous fluid in approved containers, and dispose of it according to applicable guidelines. • Always wear impervious gloves when spraying or cleaning equipment.
	<p>PERSONAL PROTECTIVE EQUIPMENT</p> <p>You must wear appropriate protective equipment when operating, servicing, or when in the operating area of the equipment to help protect you from serious injury, including eye injury, inhalation of toxic fumes, burns, and hearing loss. This equipment includes but is not limited to:</p> <ul style="list-style-type: none"> • Protective eyewear • Clothing and respirator as recommended by the fluid and solvent manufacturer • Gloves • Hearing protection

Gun Selection

Conventional Guns

Excellent atomization and high production rates typically with some reduction in transfer efficiency.





HVLP Guns

An HVLP gun is a high transfer efficiency gun which limits the air pressure at the air cap to 10 psi (0.07 MPa, 0.7 bar) maximum. In some areas, an HVLP gun is required for compliance with environmental standards.

Compliant Guns

A compliant gun is a high transfer efficiency gun which has been tested to have a transfer efficiency greater than or equal to HVLP guns. The Graco compliant guns have no restrictions on air cap pressures, but the gun inlet pressure must remain under the maximum compliant pressure shown on pages 3-4 to remain in compliance.

Setup

						
At least one hose must provide a static ground to the gun.						

Connect Air and Fluid Lines

1. Shut off the air supply.
2. Install a shutoff valve (not supplied) downstream of the air regulator to shut off gun air.
3. Install an inline air filter (not supplied) to clean and dry the gun air supply.
4. Connect a clean, dry, filtered air supply to the air inlet fitting. See FIG. 1.



- Recommended 5/16 in. (7.9 mm) ID hose, optional 3/8 in. (9.5 mm) ID hose.
- Check that your shop air provides adequate air flow. See **Technical Data**, page 23, for minimum cfm requirements.
- Set shop air pressure regulator (not supplied) according to fluid manufacturer's recommendation. See maximum compliant air pressure on air cap.
- Make sure no air restrictions, such as low-volume cheater valves, obstruct the air flow.

5. Connect a fluid hose to the fluid inlet fitting. See FIG. 1.

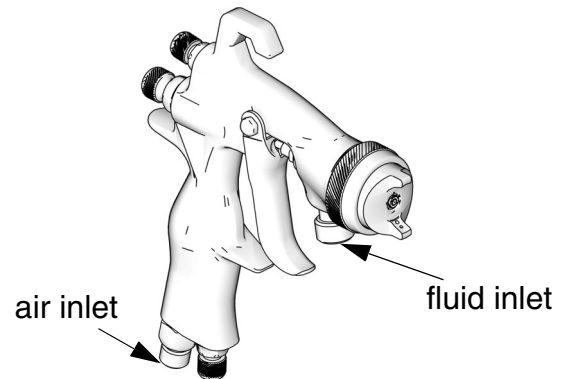

FIG. 1

ti11094a

6. Connect other end of the fluid hose to a regulated fluid supply line.

Ground the Gun

Check your local electrical code and pump manual for detailed grounding instructions.

Ground the spray gun through connection to a Graco-approved grounded fluid or air supply hose.

Flush Before Using Equipment

The equipment was tested with lightweight oil, which is left in the fluid passages to protect parts. To avoid contaminating your fluid with oil, flush the equipment with a compatible solvent before using the equipment. See **Flush**, page 10.

Adjust Spray Pattern

1. Rotate the air cap to achieve desired spray pattern. See FIG. 2.

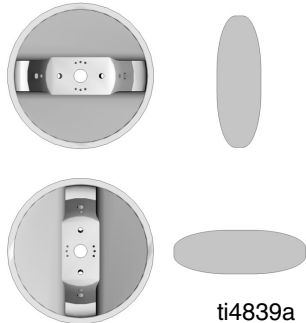

FIG. 2

2. To achieve full fan pattern, open the air control valve by turning the knob fully counterclockwise. See FIG. 3.
3. To create a round pattern, turn the pattern air off by turning the air control valve fully clockwise. See FIG. 3.
4. Trigger gun and adjust gun air pressure. Refer to **Technical Data**, page 23, for inlet air pressure recommendations.
5. To establish the correct fluid flow, turn the fluid control valve counterclockwise until no restriction of the trigger movement is felt, then turn out another half turn.

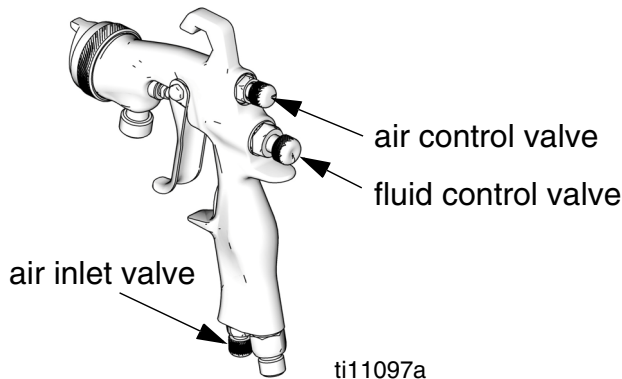

FIG. 3

6. Adjust fluid pressure to achieve desired fluid flow rate.

7. To reduce fluid flow, turn the fluid control valve clockwise.



- If the fluid control valve is turned clockwise all the way, the gun will emit only air.
- If you cannot achieve the correct fluid flow with the fluid control valve, a different sized nozzle may be necessary. For smaller fluid flow, use the next size smaller nozzle. For a larger fluid flow, use the next size larger nozzle.





8. Spray a test pattern. Evaluate the spray pattern size and atomization.

9. To achieve a narrow spray pattern, turn air control valve clockwise.

10. To improve atomization, reduce the fluid flow rate. Increasing the air pressure can improve atomization but may result in poor Transfer Efficiency (TE) or non-compliant operation.

Operation

Pressure Relief Procedure

						
Trapped air can cause the pump to cycle unexpectedly, which could result in serious injury from splashing or moving parts.						

1. Turn off air and fluid supply.
2. Hold a metal part of the gun firmly to a grounded metal pail. Trigger the gun to relieve pressure.

Apply Fluid

NOTICE
Excessive atomizing air pressure can increase overspray, reduce transfer efficiency, and result in a poor quality finish. Regulatory agencies in some states prohibit the operation of a spray gun above 10 psi (69 kPa, 0.7 bar) atomizing air cap pressure.

1. Turn on shop air and fluid supply to the gun. Set atomizing pressure and fluid pressure with the gun fully triggered.
2. Adjust the pattern size and shape. See page 8.
3. To achieve the best results when applying fluid:
 - Keep the gun perpendicular and 6 to 8 inches (150 to 200 mm) from object being sprayed.
 - Use smooth, parallel strokes across the surface to be sprayed with 50% overlap.





NOTE: See Troubleshooting, page 12, if you experience an irregular pattern.

When using the HVLP spray gun, instead of a conventional airspray gun, you may need to use a slightly slower hand movement and make fewer passes with the gun to coat a part. This is due to the reduced spray velocity produced by lower HVLP air pressures, along with a larger fluid particle size because there is less air to blow off solvents than is produced by conventional airspray. Take care to avoid runs or sags as you spray.

Volatile Organic Compounds (VOC) Regulation

In certain states, spraying solvents that release VOCs into the atmosphere when cleaning a spray gun is prohibited. To comply with these air quality laws, you must use a cleaning method that prevents the escape of VOC vapors into the atmosphere. See **Compliant Cleaning Methods**, page 11.

Daily Gun Maintenance

						
<p>Follow Pressure Relief Procedure, page 9, when you stop spraying and before cleaning, checking, servicing, or transporting equipment. Read Warnings, page 5.</p>						

General Tasks

- Frequently lubricate the gun moving parts with a drop of non-silicone oil.
- Do not disassemble the spray gun if you are having a spray pattern problem. See **Troubleshooting**, page 12, for information on how to correct the problem.
- Follow the **Pressure Relief Procedure**, page 9.
- Clean the fluid and air line filters daily.
- Check for any fluid leakage from gun and fluid hoses.

NOTICE
<p>Solvent left in gun air passages could result in a poor quality paint finish. Do not use any cleaning method that may allow solvent into the gun air passages.</p> <ul style="list-style-type: none"> • Do not point gun up while cleaning it. • Do not wipe gun with a cloth soaked in solvent; wring out the excess. • Do not immerse the gun in solvent.

Flush

Flush before changing colors, before fluid can dry in the equipment, at the end of the day, before storing, and before repairing equipment. Flush at the lowest pressure possible. Check connectors for leaks and tighten as necessary. Flush with a fluid that is compatible with the fluid being dispensed and the equipment wetted parts.

NOTE: See Compliant Cleaning Methods, page 11, to comply with air quality laws if applicable.

1. Follow **Pressure Relief Procedure**, page 9.
2. Disconnect the fluid supply hose and air supply hose from gun.
3. Connect the solvent supply hose to the gun.
4. Start the pump. Always use the lowest possible fluid pressure when flushing.
5. Hold a metal part of the gun firmly to a grounded metal pail. Trigger the gun until clean solvent dispenses.
6. Turn off solvent supply.
7. Follow **Pressure Relief Procedure**, page 9,
8. Disconnect the solvent supply hose from the gun.

Clean Gun

NOTICE

- Do not submerge gun in solvent. Solvent dissolves lubricant, dries out packings, and clogs air passages.
- Do not use metal tools to clean air cap holes as this may scratch them and distort the spray pattern.
- Use a compatible solvent.

1. Flush, page 10.
2. Remove air cap. Trigger gun, remove nozzle, and soak both in a compatible solution.

NOTICE

Trigger the gun whenever you tighten or remove the nozzle. This keeps the needle tip away from the nozzle seating surface and prevents the tip from being damaged.

3. Dip the end of a soft-bristle brush into a compatible solvent. Do not continuously soak the brush's bristles with solvent and do not use a wire brush.
4. With the gun pointed down, clean the front of the gun, using a soft-bristle brush and solvent.
5. Scrub the air cap retaining ring, air cap, and fluid nozzle with the soft-bristle brush.



- To clean out air cap holes, use a soft implement, such as a toothpick, to avoid damaging critical surfaces.
- Clean the air cap and fluid nozzle daily, minimum. Some applications require more frequent cleaning.
- Do not soak the air cap retaining ring in solvent for prolonged periods of time.





6. Trigger the gun while you install the fluid nozzle with the gun tool. Tighten the nozzle securely to 155-165 in-lb (17.5-18.6 N•m) to obtain a good seal.
7. Install the retaining ring (14) and air cap (13b).
8. Dampen a soft cloth with solvent and wring out the excess. Point the gun down and wipe off the outside of the gun.
9. After cleaning the gun, lubricate the following parts with lubricant 111265 daily:
 - fluid control valve threads
 - trigger pivot pin
 - fluid needle shaft

Compliant Cleaning Methods

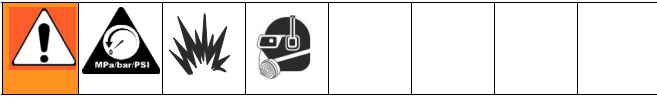
1. Place spray gun in a gun washer that completely encloses gun and components during cleaning, rinsing, and draining.
2. Spray solvent through the spray gun into a closed gun cleaning station.

Troubleshooting



Problem	Cause	Solution
Spray Pattern  Right	Normal pattern.	No action necessary.
Spray Pattern  Wrong Heavy top or bottom	Dirty or damaged air cap or fluid nozzle.	Rotate air cap (13) 180°. <i>If pattern follows air cap, problem is in air cap. Clean and inspect. If pattern is not corrected, replace air cap.</i> <i>If pattern does not follow the air cap, the problem is with the fluid nozzle (11). Clean and inspect the nozzle. If the pattern is not corrected, replace nozzle.</i>
Spray Pattern  Wrong Split pattern	Pressure too high for viscosity of material being sprayed.	Reduce air pressure and increase material viscosity. Correct pattern by narrowing fan size with the fluid control valve (8).
Spray Pattern  Wrong	Dirty or distorted air horn holes.	Clean and inspect air cap (13). If pattern is not corrected, replace air cap.

Problem	Cause	Solution
Gun spitting.	Air getting into paint stream.	Check if fluid source is empty and fill. Tighten fluid nozzle (11). Check and tighten needle packing nut (9a). Check fluid nozzle (11) for damage.
Will not spray.	Fluid control valve (8) turned too far clockwise.	Adjust fluid control valve (8) counterclockwise.
	Fluid source empty.	Refill.
Excessive air blowing back.	Loose fluid nozzle (11).	Tighten fluid nozzle (11).
	Damaged fluid nozzle seal (19).	Replace seal (19).
Excessive air leak behind trigger.	Worn u-cups/air valve.	Repair gun (Kit 289407). Be sure to use all included parts.
	Worn trigger.	Replace trigger (part 289140). If leak persists repair gun (Kit 289407).
Gun fluid pressure is too high with gun triggered (cannot achieve desired flow rate).	Using needle/nozzle kit with too small orifice.	Use needle/nozzle kit with larger orifice.
Using a low fluid pressure setting, the fluid flow is too high, making it necessary to restrict needle travel to reduce fluid flow.	Using needle/nozzle kit with too large orifice.	Use needle/nozzle kit with smaller orifice.
Fluid system will not operate at low enough pressure [below 10 psi (70 kPa, 0.7 bar)].	There is no fluid regulator, or air regulator is not sensitive enough at low pressure.	Add low pressure fluid regulator, or add more sensitive low pressure air regulator.
Fluid flow is fluttering while spraying.	Fluid filter clogged.	Check fluid filter.
	Fluid source empty.	Refill.
Fluid flow fades while spraying high viscosity fluids.	Air hose size is too restricted for higher air flow being used.	Use 5/16 in. (7.9 mm) I.D. air hose if the hose is 25 ft (7.6 m) long. If longer hose is needed, use a 3/8 in. (9.5 mm) I.D. hose.

Repair

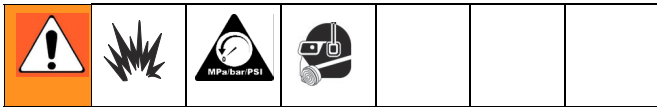

Follow **Pressure Relief Procedure**, page 9.

See **Parts**, page 16, for callout references.

Disassembly

1. Unscrew retaining ring (14) to remove air cap (13b). Check o-rings (13a and 13c) and replace if necessary.
2. Trigger gun while unscrewing nozzle (11) to prevent needle damage.
3. Check o-ring (19) and replace if necessary.
4. Remove fluid control valve (8), spring (26), needle (9), and nut (7). Inspect. Replace tip (9c), needle (9), and u-cup seal (20) as necessary. If replacing needle tip, use low strength thread adhesive on needle tip threads.
5. Remove spring (28) and push the air valve assembly (6) out the back of the gun. Inspect. Replace air valve assembly (6) and u-cup seal (20) as necessary. Use tool (33) to install u-cup seal.
6. Remove trigger nut (22), trigger pin (21), wave washer (18), and trigger (10).
7. Unscrew needle packing nut (17) and remove u-cup packing (16) and spreader (15).
8. Remove air control valve assembly (5). Inspect and replace as necessary.
9. Remove air inlet valve assembly (27) [36 on Models 24U187 and 24U188]. Inspect and replace as necessary.

NOTE: Do not remove the fluid inlet fitting. It was attached to the gun body with permanent thread locker. There is also no need to remove the air inlet fitting.

Reassembly

1. Install air control valve assembly (5) with valve turned fully counterclockwise to outermost position. Torque to 85-90 in-lb (9.6-10.2 N•m).
2. Install air inlet valve assembly (27 [36 on Models 24U187 and 24U188]) with valve turned fully counterclockwise to outermost position. Torque to 205-215 in-lb (23.2-24.3 N•m).
3. Lubricate u-cup spreader (15) and u-cup packing (16). Install spreader (15) with tapered end facing rear of gun. Install u-cup packing (16) with open end facing front of gun. Install packing nut (17). Torque to 3 in-lb (0.3 N•m).
4. Install wave washer (18) with cupped side toward the gun body. Lubricate and apply thread retainer to trigger pin (10). Install trigger (10), trigger pin (21), and trigger nut (22). Torque to 15-20 in-lb (1.7-2.3 N•m).
5. Install air valve assembly (6), spring (28), and nut (7). Torque to 175-185 in-lb (19.8-20.9 N•m).
6. Install needle (9) and spring (26). Lightly lubricate and install fluid control valve (8).
7. Trigger gun while replacing nozzle (11). Torque to 155-165 in-lb (17.5-18.6 N•m).
8. Install air cap assembly (13) and retaining ring (14).

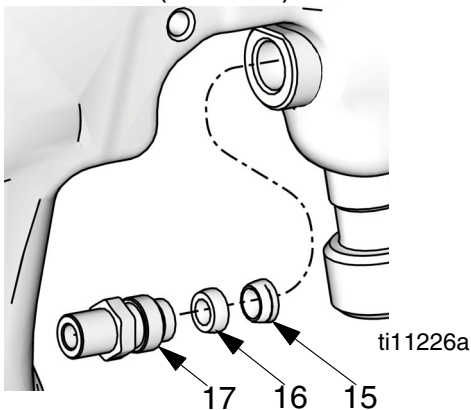

Parts

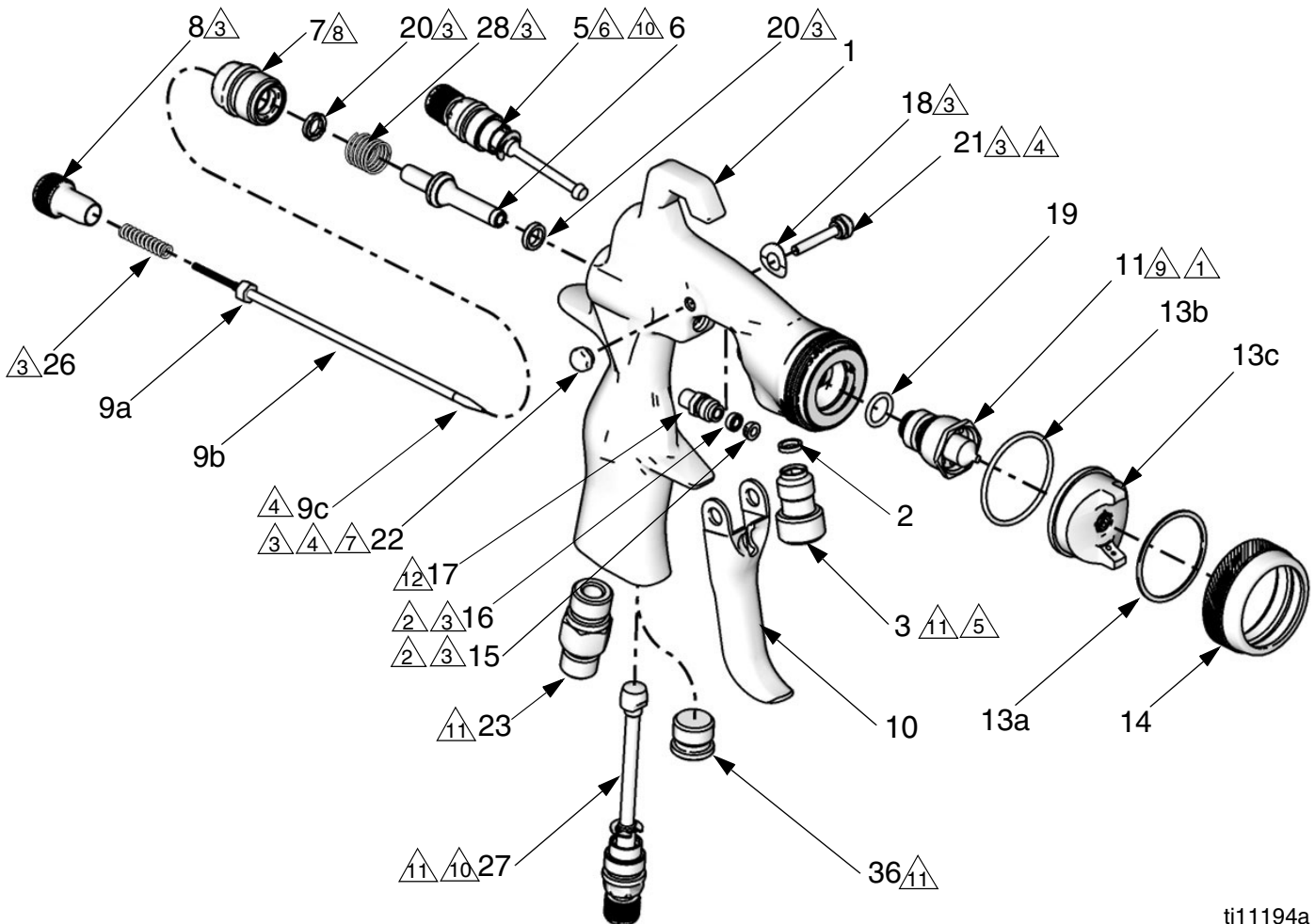

ti11194a

- ① Pull trigger before installing nozzle (11).
- ② Insert spreader (15) with tapered end facing rear of gun.
Insert u-cup (16) with open end facing front of gun.
- ③ Apply lubricant.
- ④ Apply low strength thread retainer.
- ⑤ Apply high-strength thread retainer.
- ⑥ Torque to 85-90 in-lbs (9.6-10.2 N•m).
- ⑦ Torque to 15-20 in-lbs (1.7-2.2 N•m).
- ⑧ Torque to 175-185 in-lbs (19.8-20.9 N•m).
- ⑨ Torque to 155-165 in-lbs (17.5-18.6 N•m).
- ⑩ Install with valve assembly turned fully
counterclockwise to outermost position.
- ⑪ Torque to 205-215 in-lbs (23.2-24.3 N•m).
- ⑫ Torque to 3 in-lbs (0.3 N•m).

Ref.	Part	Description	Qty.				
				21✘	---	PIN, pivot	1
				22✘	---	PIN, pivot, nut	1
1❖	289016	BODY, gun	1	23	289451	FITTING, air inlet	1
2‡❖	---	GASKET, fluid inlet	1	26*	---	SPRING, compression	1
3‡❖	---	FITTING, fluid inlet	1	27**	289142	VALVE, assembly, air inlet	1
5	289796	VALVE, air control assembly	1	28*	---	SPRING, compression	1
6★*	289038	VALVE, air, assembly	1	29	289794	TOOL, gun	1
7*	289052	NUT, air valve, u-cup assembly	1	33★*	---	TOOL, installation, seal	1
8	289097	VALVE, fluid control	1	36	289452	NUT, air plug (not assembled)	1
9	see p. 20-22	NEEDLE, assembly (includes 9a-9c)	1				
9a	---	NUT, needle	1				
9b	---	NEEDLE	1				
9c	see p. 20-22	TIP, needle	1				
10	289140	TRIGGER, gun	1				
11	see p. 20-22	NOZZLE, fluid, pressure feed	1				
13	see p. 20-22	AIR CAP, assembly (includes 13a-13c)	1				
13a★◆✓	---	WASHER	1				
13b★◆✓	---	O-RING	1				
13c	see p. 20-22	AIR CAP	1				
14✓	---	RING, retaining	1				
15★+❖	---	SPREADER, u-cup	1				
16★+❖	---	PACKING, u-cup	1				
17❖	289793	NUT	1				
18✘	---	WASHER, wave	1				
19★	111457	PACKING, o-ring	1				
20★*	---	PACKING, u-cup, gun	2				

★ *Included in Gun Repair Kit 289399.*

✘ *Included in Trigger Repair Kit 289143 (contains 5 of each part).*

+ *Included in Needle Packing Repair Kit 289455 (contains 5 of each part).*

* *Included in Air Valve Repair Kit 289407.*

◆ *Included in Air Cap Seal Kit 289791 (contains 5 of each part).*

✓ *Included in Retaining Ring Kit 289079.*

❖ *Included in Gun Body Kit 289016.*

‡ *Included in Fluid Inlet Fitting Kit 24C269.*

** *Not included in Models 24U187 and 24U188.*

--- *Not sold separately.*

Accessories

Repair Kits

Part No.	Description
289455	Needle Packing Repair Kit
289399	Gun Repair Kit
289791	Air Cap Seal Kit
289143	Trigger Repair Kit
289407	Air Valve Repair Kit
289079	Retaining Ring Kit
24C269	Fluid Inlet Fitting Kit
24C310	Nozzle O-Ring Kit, 5-pack
289016	Gun Body Kit
288986	Gun without needle, nozzle, or air cap, with 3/8 npsm (R3/8-19) fluid inlet
289419	Gun without needle, nozzle, or air cap, with 1/4 npsm (R1/4-19) fluid inlet
195065	Steel Air Inlet Fitting

Air Valves and Regulators

Part No.	Description
234784	Air Control Valve with Gauge
235119	Gun Air Regulator Assembly
239655	Swivel Air Valve

Cups

Part No.	Description
239802	1 qt SST Pressure Cup with Single Air Regulator
239803	1 qt SST Pressure Cup with Double Air Regulator
239804	1 qt SST Pressure Cup with Remote Air Regulator
240266	Disposable Polyethylene Cup Liners (40 pack), for 1 qt siphon and pressure cups only
235117	2 qt Pressure Cup with Regulator and Hose

Cleaning Kits

Part No.	Description
105749	Cleaning Brush
111265	Gun Lubricant
15C161	Ultimate Gun Cleaning Kit

Test Gauges

Part No.	Description
289803	HVLP Automotive Verification
289563	HVLP General Metal 0.5 - 1.8 mm (0.020-0.070 in.) Verification
289564	HVLP General Metal 2.2 mm (0.086 in.) Verification
289565	HVLP General Metal 2.8 mm (0.110 in.) Verification
289566	HVLP Stain Verification
289567	HVLP Waterborne Verification
289568	HVLP High Wear 1.5 mm (0.059 in.) Verification
289569	HVLP High Wear 1.8-2.2 mm (0.070-0.086 in.) Verification

Hoses

Part No.	Description
239631	4 ft Air Whip Hose Assembly (5/16 in.)
239636	15 ft Air Hose Assembly (5/16 in.)
239637	25 ft Air Hose Assembly (5/16 in.)
239622	4 ft Fluid Whip Hose Assembly (3/16 in.)
239633	15 ft Fluid Hose Assembly (3/16 in.)
239634	25 ft Fluid Hose Assembly (3/16 in.)

Tips

Part No.	Description
24E484	.030 in. SST Needle Tips (Pack of 5)

Repair Kits

Model	Spray Type	Nozzle Size in. (mm)	Air Cap Kit (13a-13c)	Nozzle Kit (11, 19)	Needle Assembly Kit (9a-9c)	Needle/ Nozzle Kit (9a-9c, 11, 19)	Needle Tip Kit (9c, 5-pack)
General Metal Spray Guns							
288726	Conventional	0.020 (0.5)	289773	289061	289270	289458	289350
288929	Conventional	0.030 (0.8)	289773	289062	289271	289459	288183
288930	Conventional	0.042 (1.1)	289773	289063	289785	289460	288184
288931	Conventional	0.055 (1.4)	289773	289064	289799	289462	288185
288932	Conventional	0.070 (1.8)	289784	289065	289799	289464	288185
288933	Conventional	0.086 (2.2)	289068	289066	289787	289466	289004
288934	Conventional	0.110 (2.8)	289069	289067	289800	289467	289007
288935	HVLP	0.020 (0.5)	289041	289061	289270	289458	289350
288936	HVLP	0.030 (0.8)	289041	289062	289271	289459	288183
288937	HVLP	0.042 (1.1)	289041	289063	289785	289460	288184
288938	HVLP	0.055 (1.4)	289041	289064	289799	289462	288185
288939	HVLP	0.070 (1.8)	289041	289065	289799	289464	288185
288940	HVLP	0.086 (2.2)	289070	289066	289787	289466	289004
288941	HVLP	0.110 (2.8)	289043	289067	289800	289467	289007
288942	Compliant	0.020 (0.5)	289042	289061	289270	289458	289350
288943	Compliant	0.030 (0.8)	289042	289062	289271	289459	288183
288944	Compliant	0.042 (1.1)	289042	289063	289785	289460	288184
288945	Compliant	0.055 (1.4)	289042	289064	289799	289462	288185
288946	Compliant	0.070 (1.8)	289042	289065	289799	289464	288185
288947	Compliant	0.086 (2.2)	289044	289066	289787	289466	289004
288948	Compliant	0.110 (2.8)	289045	289067	289800	289467	289007
General Metal with Stainless Steel Tip							
288949	Conventional	0.042 (1.1)	289773	289063	289272	289461	289010
288950	Conventional	0.055 (1.4)	289773	289064	289273	289463	289013
288951	Conventional	0.070 (1.8)	289784	289065	289273	289465	289013
24U187**	Conventional	0.042 (1.1)	289040	289063	189272	289461	289010
24U188**	Conventional	0.055 (1.4)	289040	289064	189273	289463	289013
288952	HVLP	0.042 (1.1)	289041	289063	289272	289461	289010
288953	HVLP	0.055 (1.4)	289041	289064	289273	289463	289013
288954	HVLP	0.070 (1.8)	289041	289065	289273	289465	289013
288955	Compliant	0.042 (1.1)	289042	289063	289272	289461	289010
288956	Compliant	0.055 (1.4)	289042	289064	289273	289463	289013
288957	Compliant	0.070 (1.8)	289042	289065	289273	289465	289013
** Models 24U187 and 24U188 do not include item 27.							

Model	Spray Type	Nozzle Size in. (mm)	Air Cap Kit (13a-13c)	Nozzle Kit (11, 19)	Needle Assembly Kit (9a-9c)	Needle/ Nozzle Kit (9a-9c, 11, 19)	Needle Tip Kit (9c, 5-pack)
Automotive							
288929	Conventional	0.030 (0.8)	289773	289062	289271	289459	288183
288930	Conventional	0.042 (1.1)	289773	289063	289785	289460	288184
24D472*	Conventional	0.042 (1.1)	289040	289063	289785	289460	288184
288931	Conventional	0.055 (1.4)	289773	289064	289799	289462	288185
289034	HVLP	0.040 (1.0)	289771	289774	289785	289468	288184
289035	HVLP	0.047 (1.2)	289771	289775	289799	289469	288185
289541	HVLP	0.055 (1.4)	289771	289776	289786	289495	289001
289036	Compliant	0.040 (1.0)	289772	289777	289785	289470	288184
289037	Compliant	0.047 (1.2)	289772	289778	289799	289471	288185
289542	Compliant	0.055 (1.4)	289772	289779	289799	289497	288185
* High production							
Stain							
288958	Conventional	0.020 (0.5)	288862	288907	289270	289472	289350
288959	Conventional	0.030 (0.8)	288862	288927	289271	289473	288183
289109	Conventional	0.040 (1.0)	288862	289112	289785	289474	288184
288960	HVLP	0.020 (0.5)	288864	288907	289270	289472	289350
288961	HVLP	0.030 (0.8)	288864	288927	289271	289473	288183
289110	HVLP	0.040 (1.0)	288864	289112	289785	289474	288184
288962	Compliant	0.020 (0.5)	288863	288907	289270	289472	289350
288963	Compliant	0.030 (0.8)	288863	288927	289271	289473	288183
289111	Compliant	0.040 (1.0)	288863	289112	289785	289474	288184
Adhesives							
288982	Conventional	0.051 (1.3)	289051	289077	289799	289484	288185
288983	Conventional	0.070 (1.8)	289051	289078	289799	289485	288185
Spatter							
288985	HVLP	0.042 (1.1)	289053	289063	289785	289460	288184
Air Brush							
24F202	Conventional	0.042 (1.1)	24D705	289063	289785	289460	288184

Model	Spray Type	Nozzle Size in. (mm)	Air Cap Kit (13a-13c)	Nozzle Kit (11, 19)	Needle Assembly Kit (9a-9c)	Needle/ Nozzle Kit (9a-9c, 11, 19)	Needle Tip Kit (9c, 5-pack)
Waterborne							
288964	Conventional	0.030 (0.8)	289046	289071	289785	289475	288184
288965	Conventional	0.042 (1.1)	289046	289072	289785	289476	288184
288966	Conventional	0.055 (1.4)	289046	289073	289799	289477	288185
288967	HVLP	0.030 (0.8)	289047	289071	289785	289475	288184
288968	HVLP	0.042 (1.1)	289047	289072	289785	289476	288184
288969	HVLP	0.055 (1.4)	289047	289073	289799	289477	288185
288970	Compliant	0.030 (0.8)	289048	289071	289785	289475	288184
288971	Compliant	0.042 (1.1)	289048	289072	289785	289476	288184
288972	Compliant	0.055 (1.4)	289048	289073	289799	289477	288185
High Wear							
288973	Conventional	0.059 (1.5)	288861	289074	289352	289478	N/A
288974	Conventional	0.070 (1.8)	289049	289075	289352	289479	N/A
288975	Conventional	0.086 (2.2)	289049	289076	289351	289480	N/A
289982	Conventional	0.110 (2.8)	289049	289975	289979	289980	N/A
288976	HVLP	0.059 (1.5)	289115	289331	289352	289481	N/A
288977	HVLP	0.070 (1.8)	289325	289332	289352	289482	N/A
288978	HVLP	0.086 (2.2)	289325	289333	289351	289483	N/A
289983	HVLP	0.110 (2.8)	289325	289976	289979	289981	N/A
288979	Compliant	0.059 (1.5)	289050	289331	289352	289481	N/A
288980	Compliant	0.070 (1.8)	289327	289332	289352	289482	N/A
288981	Compliant	0.086 (2.2)	289327	289333	289351	289483	N/A
289984	Compliant	0.110 (2.8)	289327	289976	289979	289981	N/A

Needle Tips

Grooves	Needle Tip
0	289004, 289007
1	289350
2	288183
3	288184
4	288185

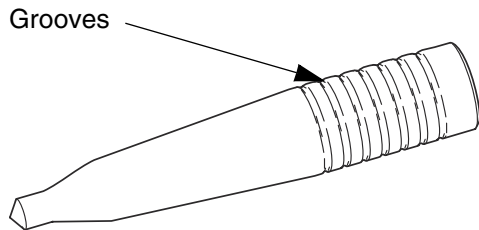

ti14043a

Technical Data

Maximum Air Inlet Pressure	100 psi (0.7 MPa, 7 bar)
Maximum Fluid Inlet Pressure	300 psi (2.1 MPa, 21 bar)
Maximum HVLP*/Compliant Inbound Air Pressure	Printed on air cap. See Models , page 3-4.
Fluid and Air Operating Temperature Range	32°-109°F (0°-43°C)
Weight	410 g
Air Inlet	1/4 npsm (R1/4-19)
Fluid Inlet	3/8 npsm (R3/8-19)
Wetted Parts	303 stainless steel, 17-4 PH stainless steel, PEEK, acetal, UHMWPE
Noise Data**	
Conventional	
Sound power at 43 psi (0.30 MPa, 3.0 bar)	88.82 dB(A)**
Sound Power at 43 psi (0.30 MPa, 3.0 bar)	78.91 dB(A)**
HVLP	
Sound power at 19 psi (0.13 MPa, 1.3 bar)	89.70 dB(A)**
Sound Power at 19 psi (0.13 MPa, 1.3bar)	79.79 dB(A)**
Compliant	
Sound power at 29 psi (0.20 MPa, 2.0 bar)	87.47 dB(A)**
Sound Power at 29 psi (0.20 MPa, 2.0 bar)	77.56 dB(A)**

* Produces 10 psi (0.07 MPa, 0.7 bar) spraying pressure at air cap.

** All readings were taken with the fan valve fully open. Sound power was tested to ISO 9614-2.

Air Consumption

Spray Type	Application	Air Inlet Pressure psi (MPa, bar)	Air Consumption (scfm)
Conventional	Stain	35 (0.24, 2.4)	15.2
HVLP	Stain	22 (0.15, 1.5)	14.8
Compliant	Stain	29 (0.2, 2.0)	13.6
Conventional	Adhesive	21 (0.14, 1.4)	11.3
Conventional	General Metal	36 (0.25, 2.5)	12.6
HVLP	General Metal	19 (0.13, 1.3)	14.9
Compliant	General Metal	29 (0.2, 2.0)	11.7
Conventional	High Wear	38 (0.26, 2.6)	17.1
HVLP	High Wear	20 (0.14, 1.4)	15.0
Compliant	High Wear	29 (0.2, 2.0)	10.7
Conventional	Waterborne	36 (0.25, 2.5)	12.6
HVLP	Waterborne	20 (0.14, 1.4)	15.0
Compliant	Waterborne	23 (0.16, 1.6)	13.1
Conventional	Automotive	36 (0.25, 2.5)	12.6
HVLP	Automotive	29 (0.2, 2.0)	14.4
Compliant	Automotive	35 (0.24, 2.4)	11.2

Graco Standard Warranty

Graco warrants all equipment referenced in this document which is manufactured by Graco and bearing its name to be free from defects in material and workmanship on the date of sale to the original purchaser for use. With the exception of any special, extended, or limited warranty published by Graco, Graco will, for a period of twelve months from the date of sale, repair or replace any part of the equipment determined by Graco to be defective. This warranty applies only when the equipment is installed, operated and maintained in accordance with Graco's written recommendations.

This warranty does not cover, and Graco shall not be liable for general wear and tear, or any malfunction, damage or wear caused by faulty installation, misapplication, abrasion, corrosion, inadequate or improper maintenance, negligence, accident, tampering, or substitution of non-Graco component parts. Nor shall Graco be liable for malfunction, damage or wear caused by the incompatibility of Graco equipment with structures, accessories, equipment or materials not supplied by Graco, or the improper design, manufacture, installation, operation or maintenance of structures, accessories, equipment or materials not supplied by Graco.

This warranty is conditioned upon the prepaid return of the equipment claimed to be defective to an authorized Graco distributor for verification of the claimed defect. If the claimed defect is verified, Graco will repair or replace free of charge any defective parts. The equipment will be returned to the original purchaser transportation prepaid. If inspection of the equipment does not disclose any defect in material or workmanship, repairs will be made at a reasonable charge, which charges may include the costs of parts, labor, and transportation.

THIS WARRANTY IS EXCLUSIVE, AND IS IN LIEU OF ANY OTHER WARRANTIES, EXPRESS OR IMPLIED, INCLUDING BUT NOT LIMITED TO WARRANTY OF MERCHANTABILITY OR WARRANTY OF FITNESS FOR A PARTICULAR PURPOSE.

Graco's sole obligation and buyer's sole remedy for any breach of warranty shall be as set forth above. The buyer agrees that no other remedy (including, but not limited to, incidental or consequential damages for lost profits, lost sales, injury to person or property, or any other incidental or consequential loss) shall be available. Any action for breach of warranty must be brought within two (2) years of the date of sale.

GRACO MAKES NO WARRANTY, AND DISCLAIMS ALL IMPLIED WARRANTIES OF MERCHANTABILITY AND FITNESS FOR A PARTICULAR PURPOSE, IN CONNECTION WITH ACCESSORIES, EQUIPMENT, MATERIALS OR COMPONENTS SOLD BUT NOT MANUFACTURED BY GRACO. These items sold, but not manufactured by Graco (such as electric motors, switches, hose, etc.), are subject to the warranty, if any, of their manufacturer. Graco will provide purchaser with reasonable assistance in making any claim for breach of these warranties.

In no event will Graco be liable for indirect, incidental, special or consequential damages resulting from Graco supplying equipment hereunder, or the furnishing, performance, or use of any products or other goods sold hereto, whether due to a breach of contract, breach of warranty, the negligence of Graco, or otherwise.

FOR GRACO CANADA CUSTOMERS

The Parties acknowledge that they have required that the present document, as well as all documents, notices and legal proceedings entered into, given or instituted pursuant hereto or relating directly or indirectly hereto, be drawn up in English. Les parties reconnaissent avoir convenu que la rédaction du présente document sera en Anglais, ainsi que tous documents, avis et procédures judiciaires exécutés, donnés ou intentés, à la suite de ou en rapport, directement ou indirectement, avec les procédures concernées.

Graco Information

For the latest information about Graco products, visit www.graco.com.

For patent information, see www.graco.com/patents.

TO PLACE AN ORDER, contact your Graco distributor or call to identify the nearest distributor.

Phone: 612-623-6921 **or Toll Free:** 1-800-328-0211 **Fax:** 612-378-3505

All written and visual data contained in this document reflects the latest product information available at the time of publication. Graco reserves the right to make changes at any time without notice.

Original instructions. This manual contains English. MM 312414

Graco Headquarters: Minneapolis
International Offices: Belgium, China, Japan, Korea

GRACO INC. AND SUBSIDIARIES • P.O. BOX 1441 • MINNEAPOLIS MN 55440-1441 • USA

Copyright 2007, Graco Inc. All Graco manufacturing locations are registered to ISO 9001.

www.graco.com
Revision P, May 2014